



# WX980 Trailer Log Splitter Parts Manual

S/N 380001 & After



## Foreword

EMB Mfg. has prepared this parts manual to assist customers in ordering quality OEM replacement parts.

Proper and regular service and replacing old, worn or broken parts with the correct Wallenstein parts are essential to prolonging the life of your Wallenstein product. Please refer to this manual before ordering any replacement parts.

All information contained in this parts manual is based on the latest product specification available at the time of printing this manual. If your product differs from the specifications contained within this manual contact EMB Mfg. for information.

EMB reserves the right to alter specifications on their products at any time.

Reproduction of this parts manual of any kind is prohibited without prior written permission from EMB Mfg.

**Note:** Log splitters with factory installed light kits will have a VIN number included. The last six numbers of this VIN number are the splitters serial number

Example: 2E9US1112BSXXXXXX  
  
Serial Number

# Table of Contents

Main Parts	4
Valve	6
Valve & Fittings	8
Hub	9
Engine & Pump	10
Cylinder	11
Rotating Base	12
4-Way Wedge (Optional)	13
Light Kit (Optional)	14
Decal Breakdown	16

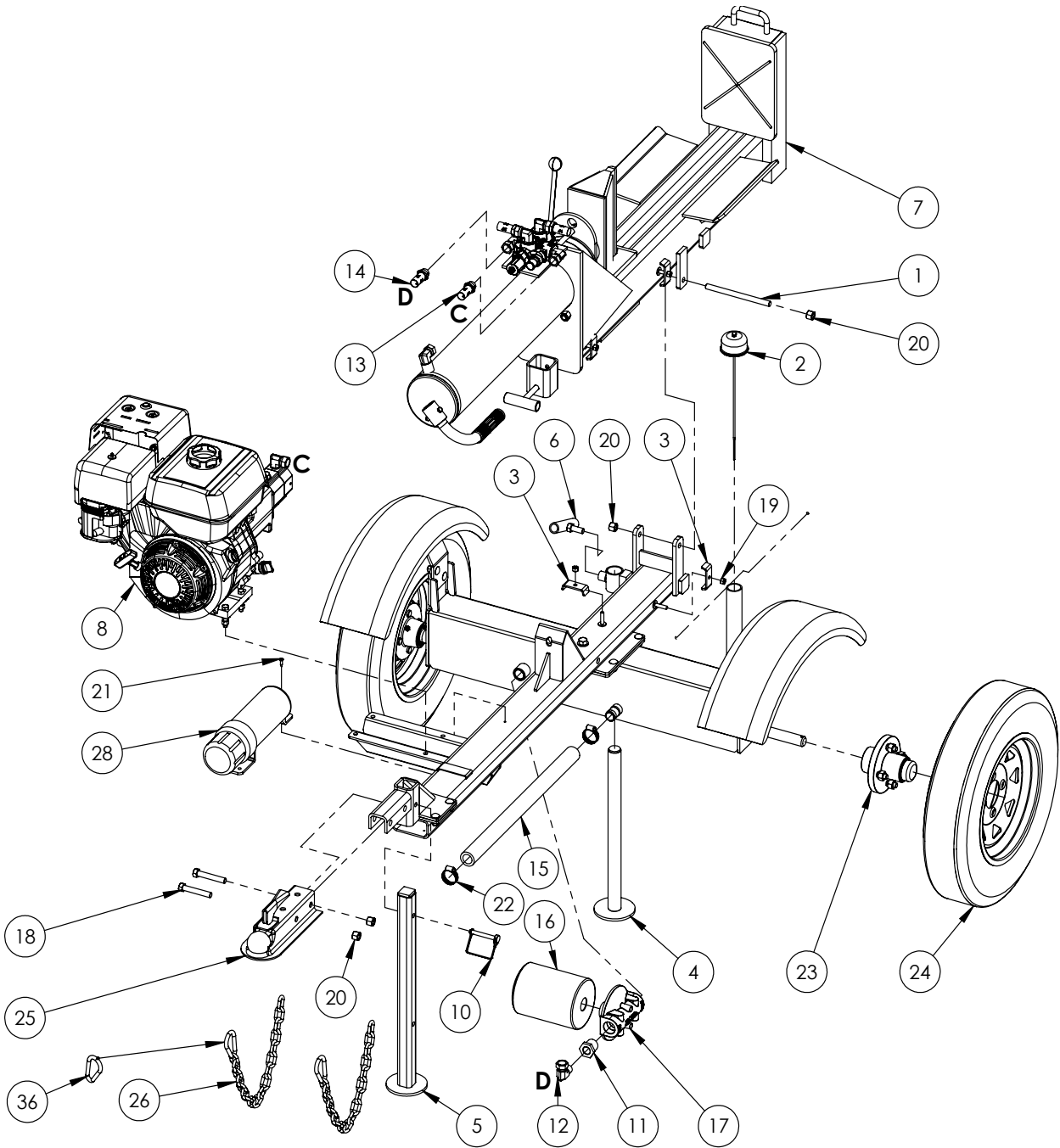

**WX980 PARTS BREAKDOWN**

ITEM	PART NO.	DESCRIPTION	QTY
1	2016M602	Pin, Pivot Threaded	1
2	2054A402	Breather cap dipstick	1
3	2054L412	Clamp, Two Hose	2
4	2054W405	Jack Stand, Rear	1
5	2054W406	Jack Stand, Front	1
6	2054W407	Handle, Rear Jack Lock	1
7	2061A101	Assembly, Splitter Base	1
8	2061A103	Assy, 9hp Engine to 16gpm Pump	1
10	Z12432	Snapper Pin 3/8 x 2-1/2	1
11	Z51223	Reducer, MP x FP 1608	1
12	Z51331	Elbow 90 MP x FPX 0808	1
13	Z52309	1/2 Hose, 1/2MPx1/2MPx 70"	1
14	Z52311	1/2 Hose, 1/2MPx1/2MPx 75"	1
15	Z52405	Suction Hose, 1" x 22"	1
16	Z55303	Oil Filter - 1" - Particulate	1
17	Z55304	Filter Cap, FP16 x FP16	1
18	Z71530	Hex Bolt 1/2NC x 3	2
19	Z72221	Hex Lock Nut 5/16NC	2

ITEM	PART NO.	DESCRIPTION	QTY
20	Z72251	Hex Lock Nut 1/2NC	4
21	Z76712	Self-tapping Screw #10	1
22	Z79401	Hose Clamp, #16	2
23	Z91202	Assembly, 1000# 4-Bolt Hub	2
24	Z91302	5.30-12 LRB SportTrail 4 Spoked	2
25	Z91614	2" Hitch Coupler	1
26	Z92303	Safety Chain 1/4 x 2'	2
27	Z92303-2	Safety Snap	2
28	Z96503	Manual Tube 3-1/2 Short	1

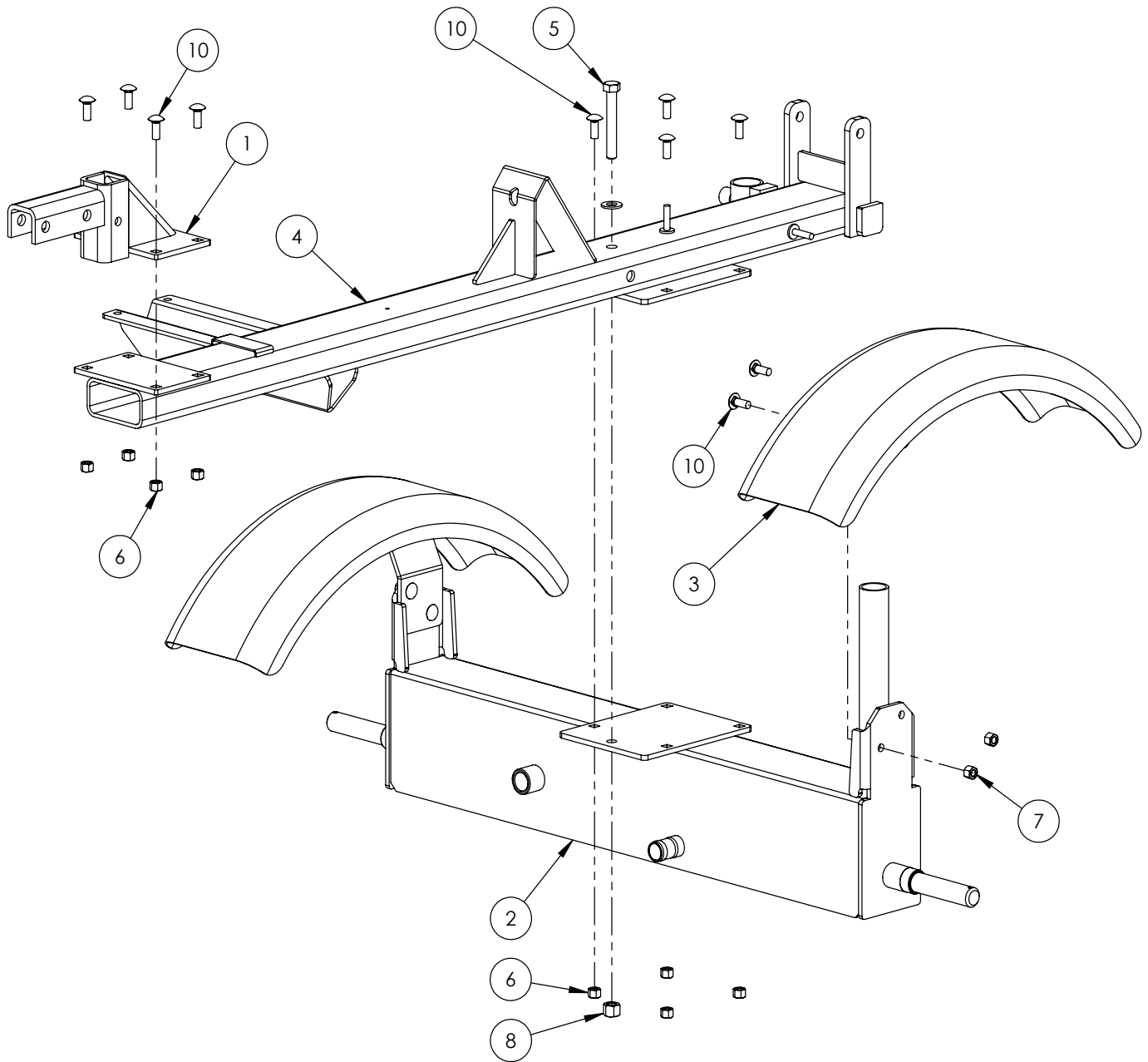

**2061A104 PARTS BREAKDOWN**

ITEM	PART NO.	DESCRIPTION	QTY
1	2054W604	Weldment, Hitch Mount	1
2	2061W102	Weldment, Main Base	1
3	2061W103	Weldment, Fender	2
4	2061W104	Weldment, WX980 Tongue	1
5	Z71535	Hex Bolt 1/2NC x 3-1/2	1
6	Z72231	Hex Lock Nut 3/8NC	8
7	Z72231	Hex Lock Nut 3/8NC	4
8	Z72251	Hex Lock Nut 1/2NC	1
9	Z73151	Flat Washer, 1/2	1
10	Z76231	Carriage Bolt 3/8NC x 1	12

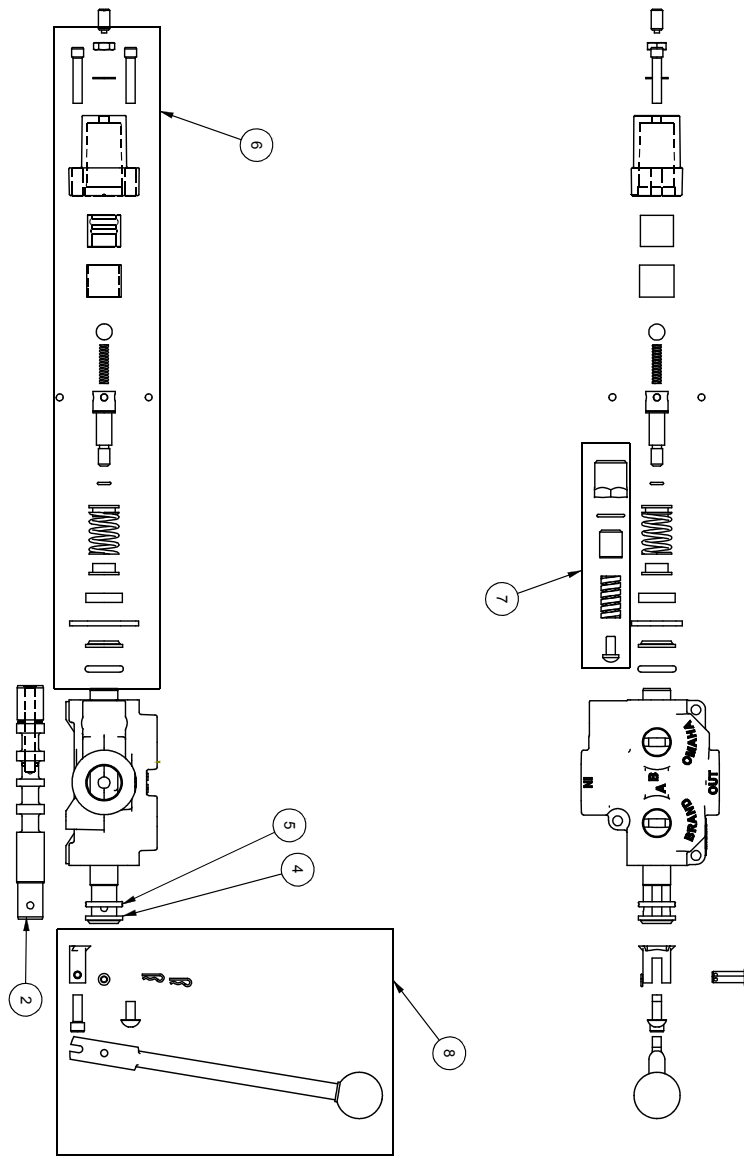

ITEM NO.	QTY.	PART NO.	DESCRIPTION
1	1	A0CASTB	AO CASTING
2	1	LS304T4J	SPOOL
3	1	P1740	NAME TAG
4	1	SF305	WIPER
5	1	SF304	QUAD RING
6	1	SUB-LS	SUB-LS
		B5057	7/16 BALL
		DC7604	3/16 BALL
1	1	SF306	RETAINER
1	1	SF477L	SH LS ENDCAP
1	1	XDC672	LS SLEEVE
2	2	SF483	SPACER
2	2	SF486	ALL EN SCREW
1	1	SF489	CENTER STOP
1	1	SF490	CENTERING SPRING
1	1	SF492	HOUSING
1	1	SF315	SPACER
1	1	LS305	DETENT SPRING
1	1	DC7583	O-RING 3-902
1	1	SF496	O-RING, BLUE, METRIC
1	1	LS306	LS WIPER
1	1	SF502	5/16 LOCK WASHER
1	1	SF503	PLUNGER, SPRING
1	1	SF504	5/16 HEX JAM NUT
7	1	SUB-R	RELIEF
1	1	P1603	CAP NUT
1	1	SF322	O-RING 2-016
1	1	SF364A	ADJ SCREW
1	1	B305	SPRING
1	1	SF361A	POPPET
8	1	Z56915	HANDLE KIT
1	1	SF377	RETAINER
1	1	SF376	SEAL RETAINER
1	1	SF367A	CLEVIS
1	1	SF368	HANDLE
2	2	SF369	PIN
2	2	P1767	PIN CLIP
1	1	HP5	MACH. SCREW
1	1	SF311	KNOB
1	1	SF308	CAP SCREW
1	1	SF303T4J	SPOOL
9	1	P1654	WARNING TAG

ITEM NO.	QTY.	PART NO.	DESCRIPTION
1	1	B5057	7/16 BALL
2	4	DC7604	3/16 BALL
3	1	SF306	RETAINER
4	1	SF477L	SH LS ENDCAP
5	1	SF480	SD SLEEVE
6	1	SF483	SPACER
7	2	SF486	ALLEN SCREW
8	2	SF489	CENTER STOP
9	1	SF490	CENTERING SPRING
10	1	SF492	HOUSING
11	1	SF315	SPACER
12	1	LS305	DETENT SPRING
13	1	DC7583	O-RING 3-902
14	1	SF496	METRIC O-RING
15	1	LS306	LS WIPER
16	1	SF502	5/16 LOCK WASHER
17	1	SF503	SPRING PLUNGER
18	1	SF504	5/16 HEX JAM NUT

Note: This diagram is for reference only. Parts not sold separately.

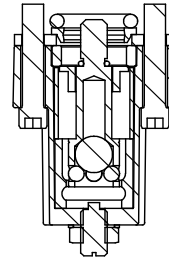
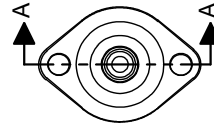
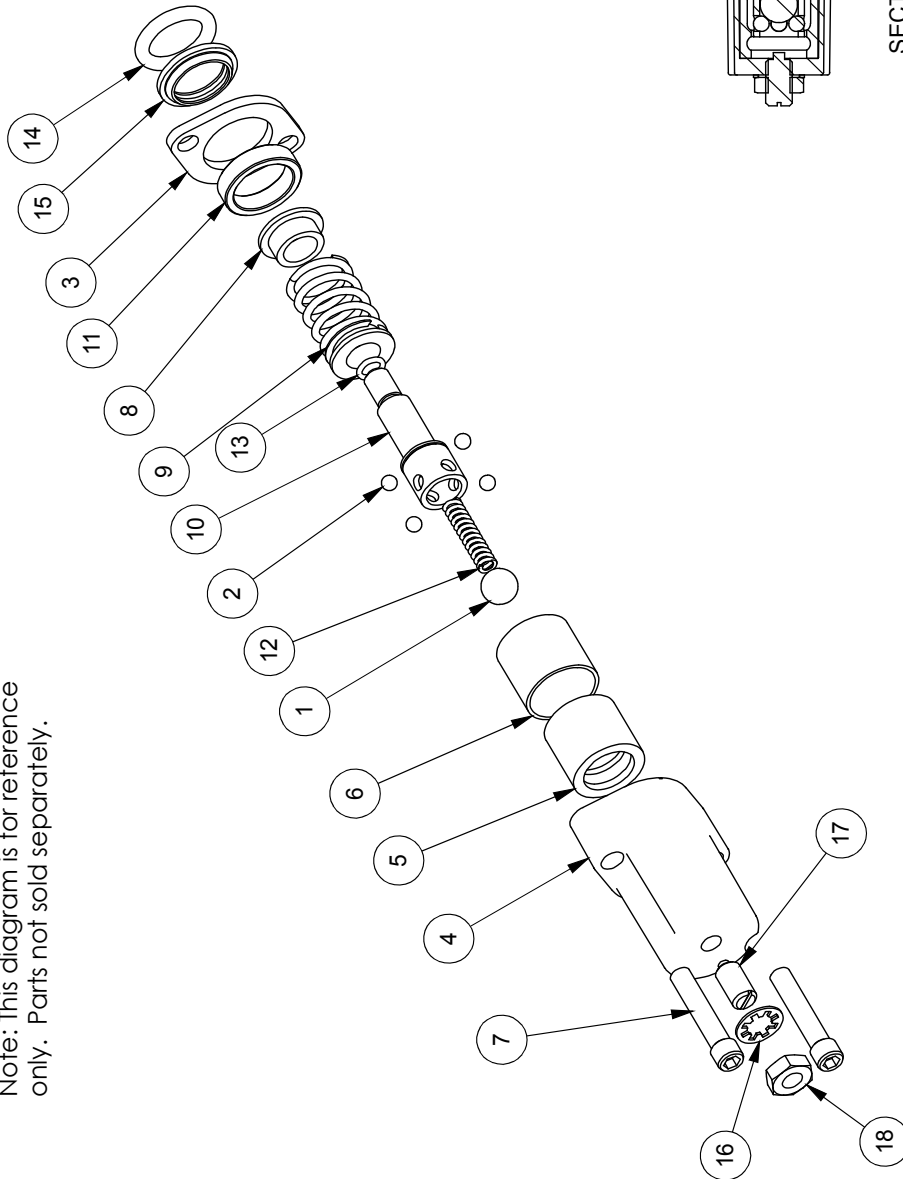

SECTION A-A

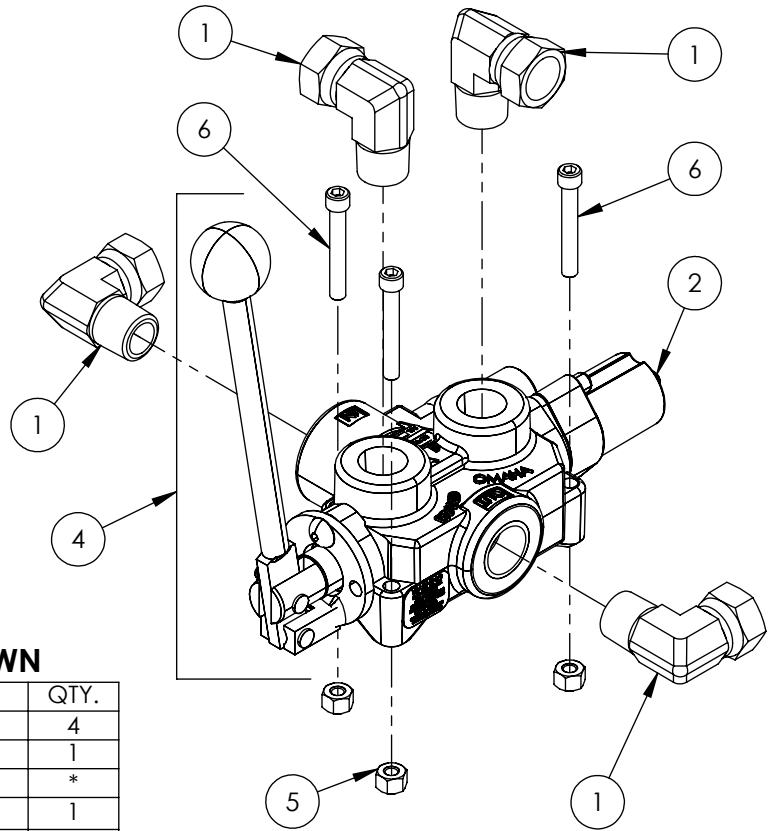

**VALVE AND FITTINGS PARTS BREAKDOWN**

ITEM	PART NO.	Description	QTY.
1	Z51331	Elbow 90 MP x FPX 0808	4
2	Z56209	Valve, Single Function Detent	1
3	*Z56210*	Valve, Closed Center	*
4	Z56915	Complete Handle Kit for Z56209	1
5	Z72111	Hex Lock Nut 1/4NC	3
6	Z75114	SHCS, 1/4NC x 1-3/4	3

\*CLOSED CENTER VALVE REQUIRED FOR "C" MODELS.\*



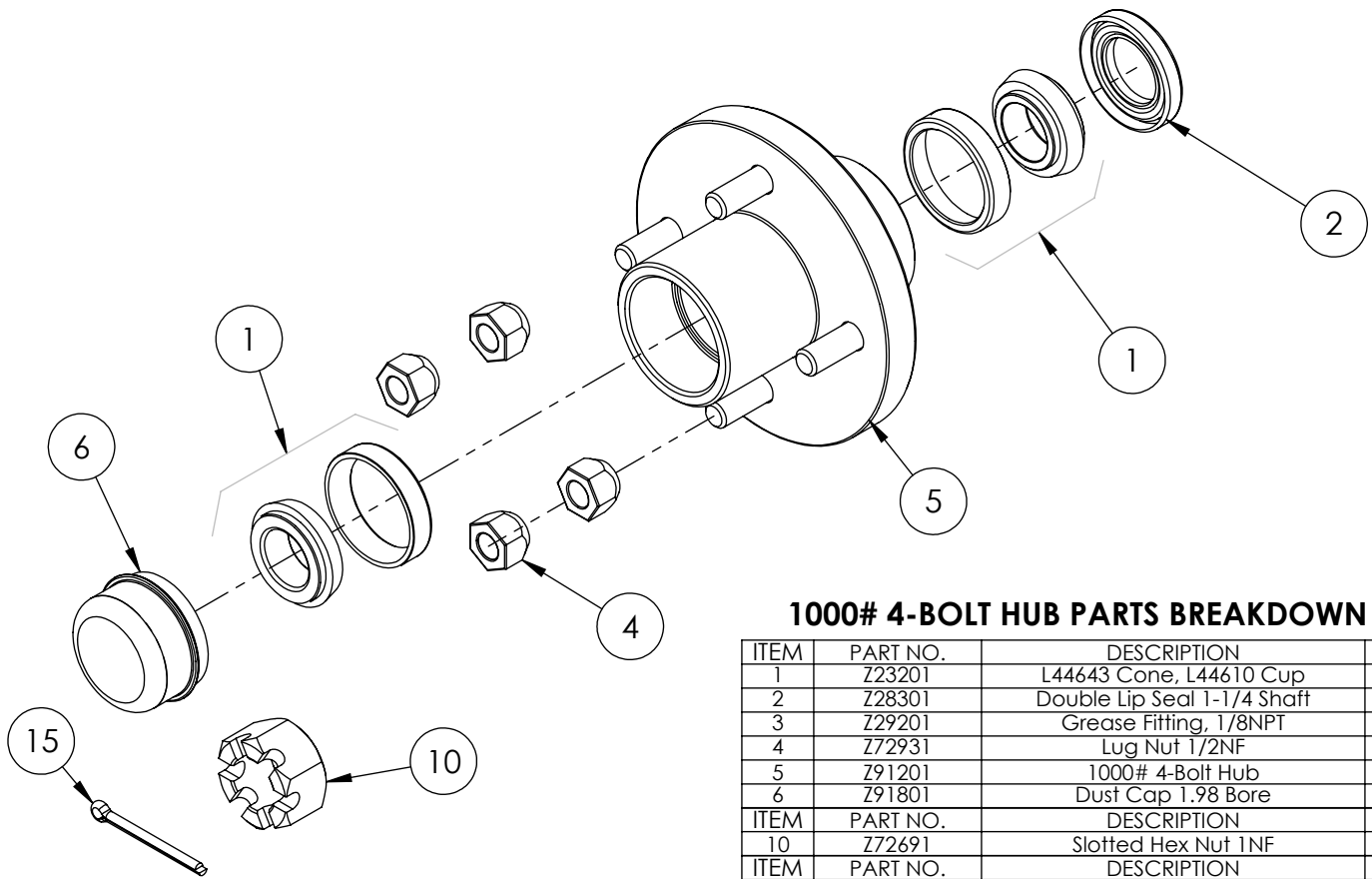

**1000# 4-BOLT HUB PARTS BREAKDOWN**

ITEM	PART NO.	DESCRIPTION	QTY
1	Z23201	L44643 Cone, L44610 Cup	2
2	Z28301	Double Lip Seal 1-1/4 Shaft	1
3	Z29201	Grease Fitting, 1/8NPT	1
4	Z72931	Lug Nut 1/2NF	4
5	Z91201	1000# 4-Bolt Hub	1
6	Z91801	Dust Cap 1.98 Bore	1
ITEM	PART NO.	DESCRIPTION	QTY
10	Z72691	Slotted Hex Nut 1NF	1
ITEM	PART NO.	DESCRIPTION	QTY
15	Z12322	Cotter Pin 3/16 X 2	1

**2061A103 9hp ENGINE / PUMP ASSEMBLY PARTS**

ITEM	PART NO.	DESCRIPTION	QTY
1	Z47136	Honda 9hp Engine	1
2	Z53802	Pump Mounting, PM-9	1
3	Z46404	Shaft Coupler L095 x 1	1
4	Z46405	Coupler Spider L095	1
5	Z46409	Shaft Coupler L095 x 1/2	1
6	Z53205	Pump, 16gpm Two-Stage	1
7	Z51331	Elbow 90 MP x FPX 0808	1
8	Z71210	Hex Bolt 5/16NC x 1	4
9	Z46533	Key 1/4 x 1/4 x 1	1
10	Z46592	Woodruff Key, 1/8 x 1/2	1
11	Z71274	Hex Bolt, 5/16NF x 1	4
12	Z71320	Hex Bolt 3/8NC x 2	4
13	Z72231	Hex Lock Nut 3/8NC	4

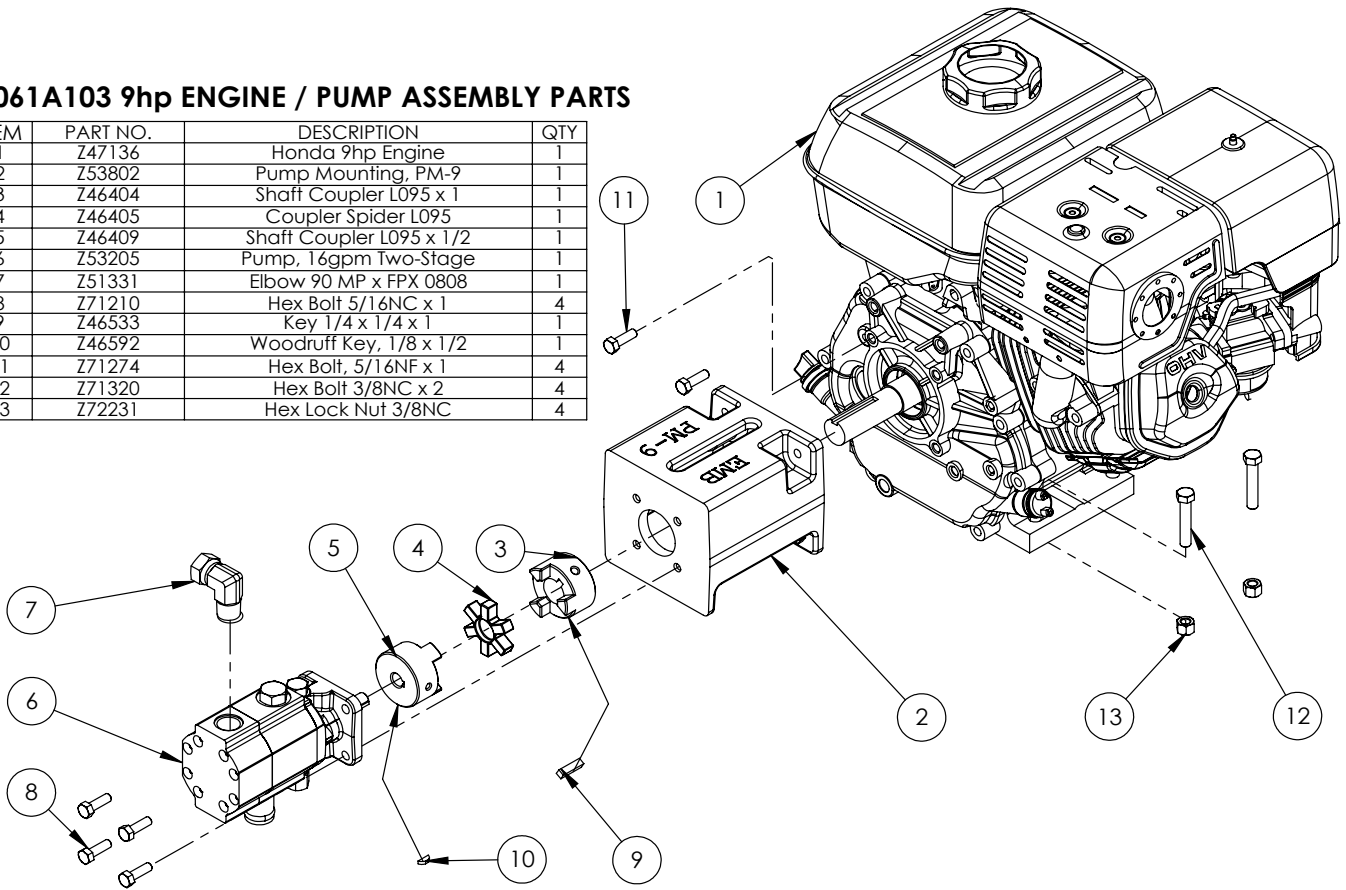

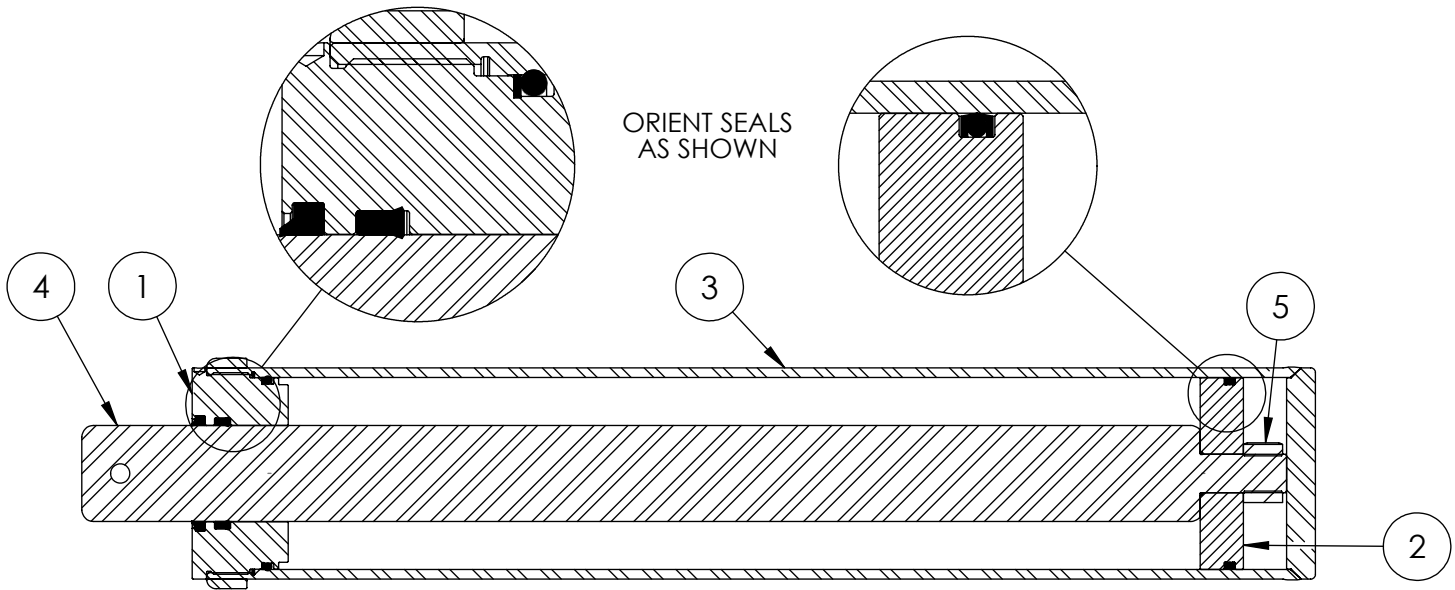

**5" x 24" STROKE CYLINDER PARTS**

ITEM	PART NO.	Description	QTY.
1	G500-250SA	5" Bore x 2-1/2" Rod Gland With Seals	1
2	P100-500SA	5" Bore Piston With Seals	1
3	2015C5014	Barrel, 5"	1
4	2015C5012	Rod, 2-1/2x 1	1
5	Z72292G8	Hex Lock Nut 1NF Grade 8	1
6	SLK-5025	Seal Kit, 5 x 2-1/2	1

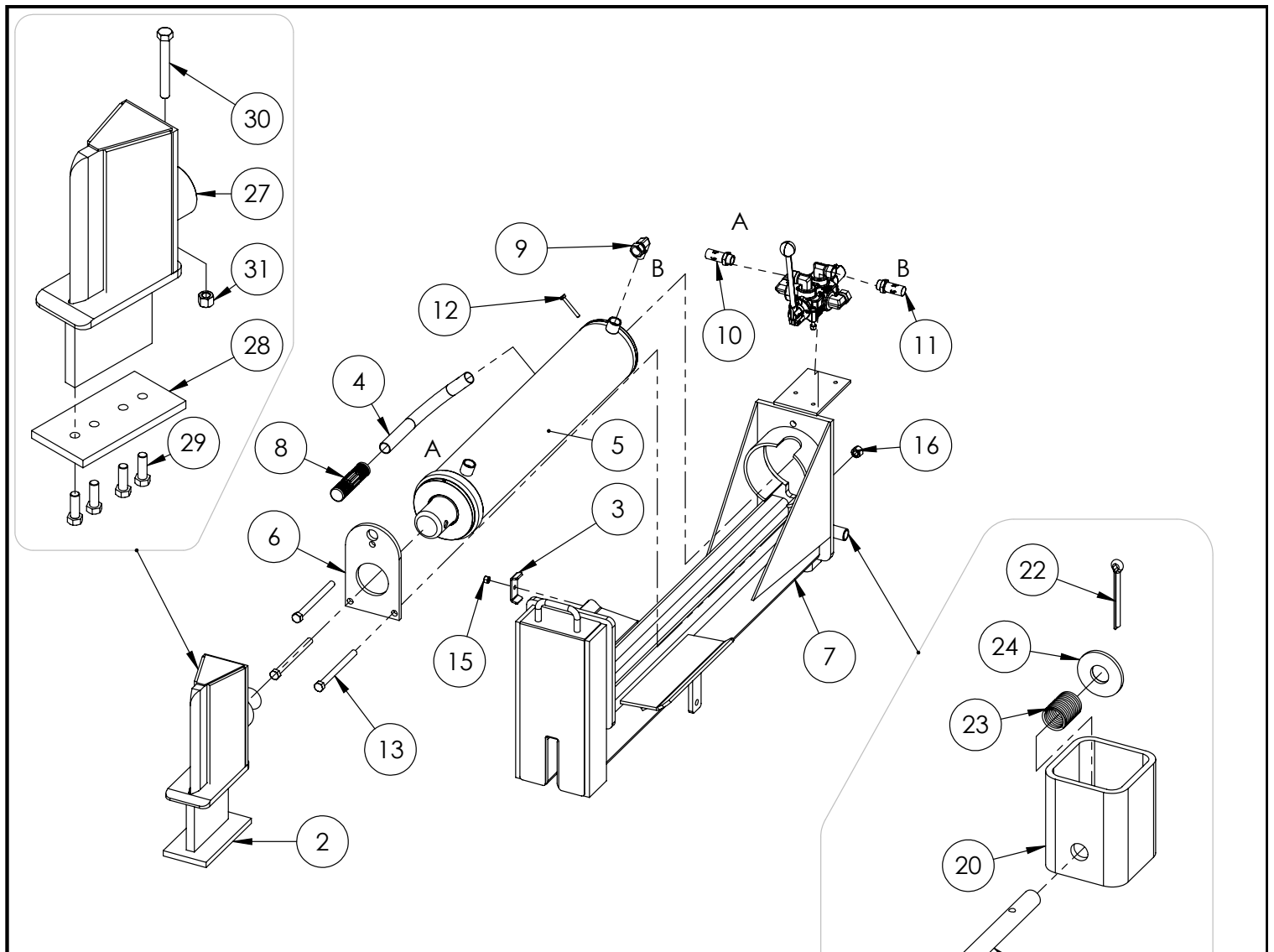

**WX980 ROTATING BASE PARTS BREAKDOWN**

ITEM	PART NO.	Description	QTY.
1	2011A103	Assembly, Valve with Fittings	1
2	2015A505	Wedge Assy for 5" Cylinder	1
3	2054L412	Clamp, Two Hose	2
4	2054S414	Handle, Lift	1
5	2061C101	Cylinder, 5 x 24" x 2-1/2"	1
6	2061S121	Plate, Cylinder Retaining (Bolt)	1
7	2061W101	Weldment for WX980	1
8	Z19321	Grip, 1" x 5"	1
9	Z51331	Elbow 90 MP x FPX 0808	1
10	Z52301	1/2 Hose MP08 x MP08 x 16"	1
11	Z52305	1/2 Hose, MP08 x MP08 x 24"	1
12	Z71120	Hex Bolt 1/4NC x 2"	1
13	Z71560	Hex Bolt 1/2NC x 6"	3
14	Z72111	Hex Lock Nut 1/4NC	1
15	Z72221	Hex Lock Nut 5/16NC	2
16	Z72251	Hex Lock Nut 1/2NC	3
ITEM	PART NO.	Description	QTY.
20	2016S604	Housing, Latch Spring	1
21	2016W603	Handle, Spring Latch	1
22	Z12321	Cotter Pin 3/16 X 2-1/2"	1
23	Z32301	Spring 19mm x 79mm Med	1
24	Z73250	Wide Flat Washer, 1/2"	1

**2016A602 LATCH PARTS (WELDED ON)**

ITEM	PART NO.	DESCRIPTION	QTY
27	2015W505	Wedge for 5" Cylinder	1
28	2014S414	Plate, Sliding Wedge Capture	1
29	Z71576	Hex Bolt 1/2NF x 1-1/2"	4
30	Z71540	Hex Bolt 1/2NC x 4"	1
31	Z72251	Hex Lock Nut 1/2NC	1

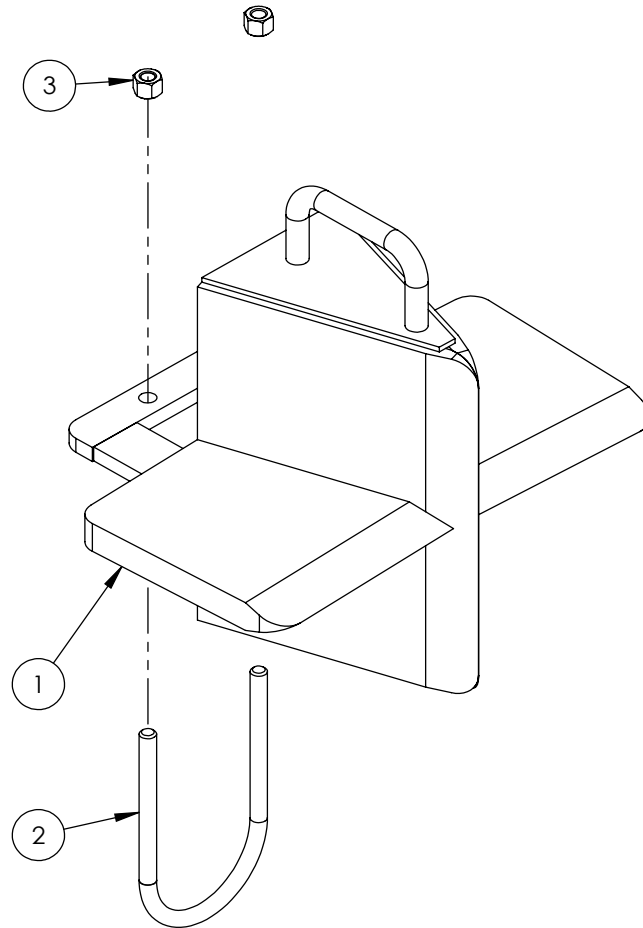

### W4130 4-Way Wedge (Optional)

ITEM	PART NO.	DESCRIPTION	QTY
1	2082W301	Weldment, Main 4-Way	1
2	2082S307	U-Bolt, 3 x 4	1
3	772231	Hex Lock Nut 3/8NC	2

# WX TRAILER SPLITTER WIRING

## RIGHT SIDE

KEY	
Bl	BLUE
Br	BROWN
Gr	GREEN
Rd	RED
Yl	YELLOW
Bk	BLACK
Wh	WHITE

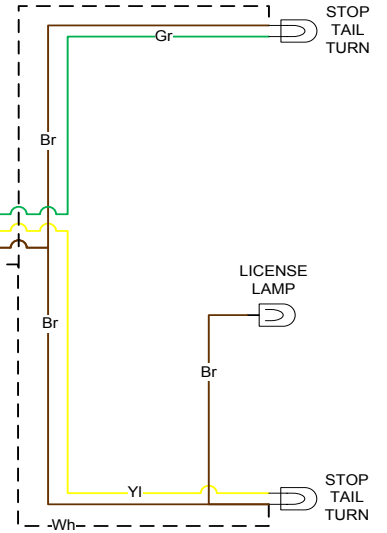
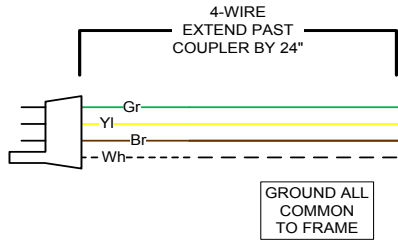

## LEFT SIDE

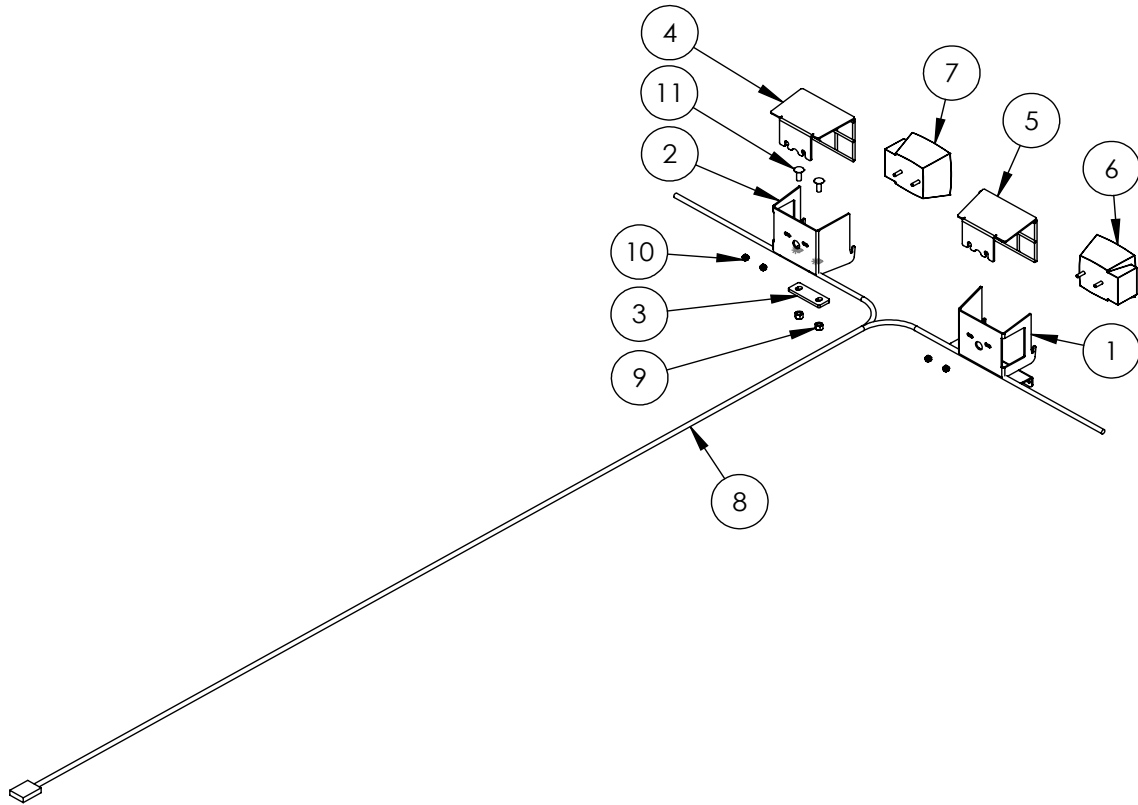

### 2089A350 LIGHT KIT (Optional)

ITEM	PART NO.	DESCRIPTION	QTY
1	2054L402	Light Bracket, LH	1
2	2054L601	Light Bracket, RH	1
3	2054L622	Bracket, Light Base	1
4	2054W403	Light Guard, RH	1
5	2054W404	Light Guard, LH	1
6	Z61106	Stop, Turn, Tail Light LH	1
7	Z61107	Stop, Turn, Tail Light RH	1
8	Z62105	110" Wishbone Trailer Harness	1
9	Z72231	Hex Lock Nut 3/8NC	2
10	Z72941	Serrated Washer Nut 1/4NC	4
11	Z76231	Carriage Bolt 3/8NC x 1	2

## HORIZONTAL-VERTICAL LOG SPLITTER DECAL BREAKDOWN

ITEM	PART NO.	DESCRIPTION	QTY
1	Z94039	CAUTION - Read Manual	1
2	Z94040	WARNING - Moving Wedge	2
3	Z94067	Clear Guide	2
4	Z94056	Wallenstein	2
5	Z94019	Made in Canada	3
6	Z94066	Apply Oil or Grease	1
7	Z94045	WARNING - Lock Stabilizer	2

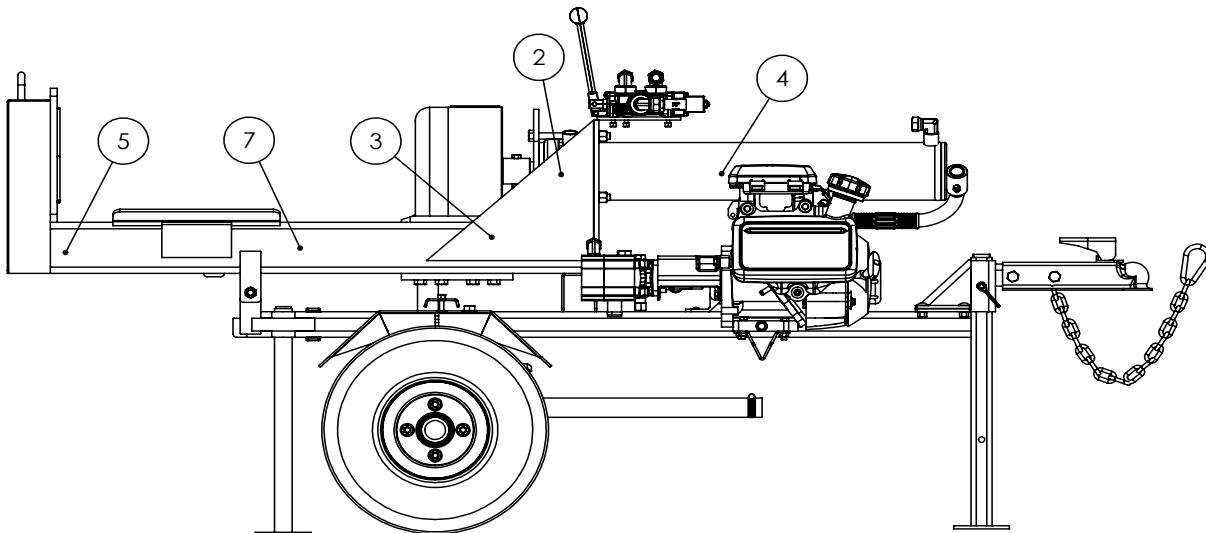
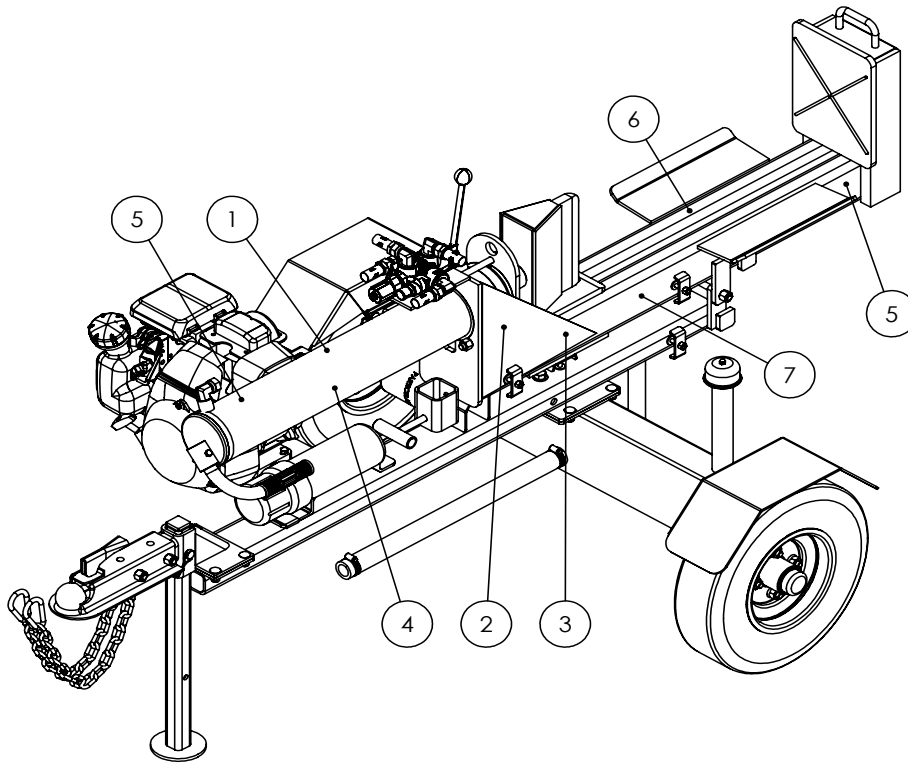



# Horizontal-Vertical Log Splitter Decals

Z94056



Z94067



Z94045

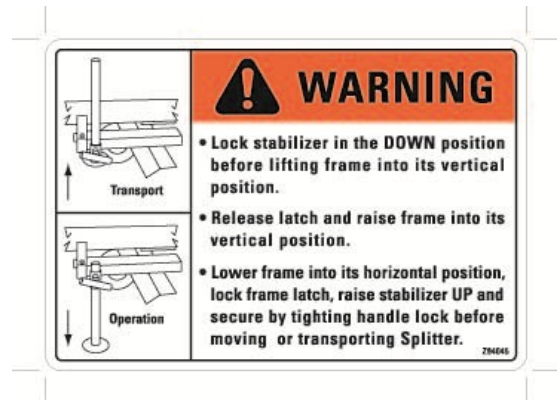

Z94066



Z94019



Z94039

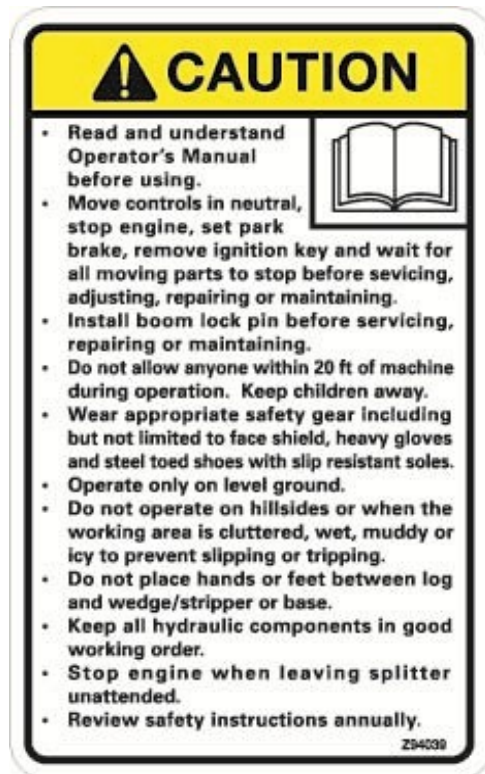

Z94040



## TWO PANEL HORIZONTAL-VERTICAL LOG SPLITTER DECAL BREAKDOWN

ITEM	PART NO.	DESCRIPTION	QTY
1	Z94119	CAUTION - Read Manual	1
2	Z94123	Keep Feet Clear	1
3	Z94067	Clear Guide	2
4	Z94056	Wallenstein	2
5	Z94019	Made in Canada	3
6	Z94124	Keep Hands Clear	1
7	Z94147	WARNING - Lock Stabilizer	2
8	Z94142	99 dB Sound Level	1

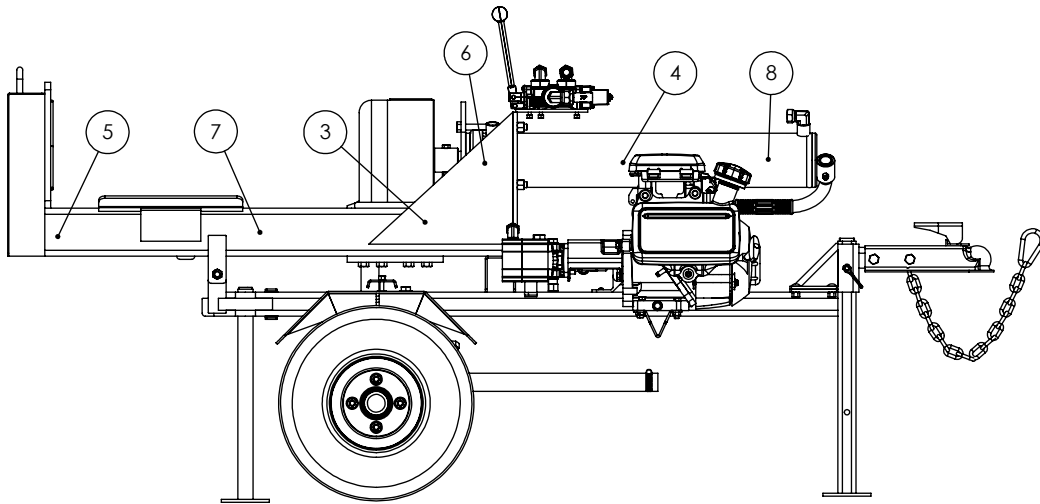
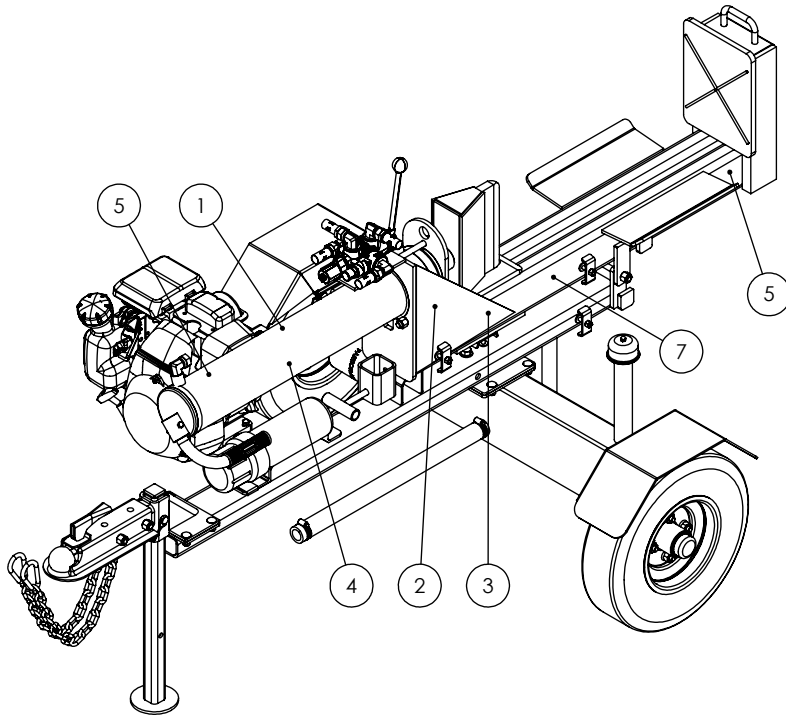

# Two Panel Horizontal-Vertical Trailer Splitter Decals

Z94067



Z94142



Z94147

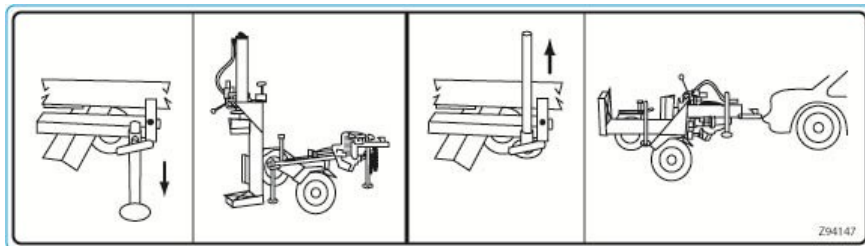

Z94019



Z94056



Z94119



Z94123



Z94124





**WALLENSTEIN Products Manufactured by:**

**EMB MFG Inc.**

4144 Boomer Line  
St. Clements, Ontario  
Canada N0B 2M0  
Phone: 1-877-695-9283  
Fax: 519-699-4146  
[www.embmfg.com](http://www.embmfg.com)