



Oregon® Mechanical Timber
Harvesting Handbook

Introduction

Our handbook provides information we consider critical to the performance (defined as production, reliability, and life of operation) and safe use of Oregon Harvester Cutting Systems.

A Harvester saw chain based cutting system is composed of a drive sprocket, guide bar, and a loop of saw chain, that is not hand-held, and designed to work with mechanical harvester machines.

In offering this information, we do not assume any responsibility for the design or manufacturer of equipment, nor the content of the literature supplied.



Safety Symbol

This safety symbol is used to highlight safety messages.

When you see this symbol, read and follow the safety message to avoid severe personal injury.

Table of Contents

Introduction

Key Safety Information	1 – 4
• Chain Shot Warning	1
• How Chain Shot Happens	2
• Minimizing the Risk of a Chain Shot Event	3
• Operator, Ground Personnel, and Bystander Safety	3
• Guard and Shields	3
• Windows	4
• A Cutting System	4
Chain Catcher	5
Chain Shot Guard	5

Operational Recommendations

Operational Parameters, Service Life, and Safety	7
Technical Data	7 – 8
Lubrication	8 – 9
Chain Tension	9 – 10
Saw Chain Speed	12
Installation and Break-In	13
Best Practices	14
• Daily Inspections	14
• Replacement Schedule	14
• Use Sharp Chain	14
• Cutting Safety	15

Saw Chain

Terminology	19 – 21
• Saw Chain Pitch	19
• Saw Chain Gauge	19
• Parts of a Cutter	20
• Parts of Saw Chain	20
• How a Cutter Works	20
Oregon® Harvester Saw Chain	
• 18HX	21 – 22
• 19HX	23 – 24
• 11H	25 – 26
• 11BC	27 – 28

Saw Chain Maintenance

Saw Chain Maintenance	29 – 30
• Clean	29
• Inspect	29
• Discard	29
• Repair	35
• Clean and Lubricate	30
Sharpening and Maintenance	31 – 38
• Filing and Grinding Angles	31
• Optional Sharpening Angles	32
Sharpening and Maintenance Tools	33 – 34
• Multi-Purpose Tool Functions	34
• Sharpening Saw Chain with a Round File	35
• Sharpening Saw Chain with a Grinder	36
• Setting the Vise Assembly	36
Grinding Wheels	37
• Vitrified Grinding Wheels	37
How to Set Depth Gauges	38

Saw Chain Repair

How to Break Out Rivets	39
Joining Saw Chain	40 – 42
Saw Chain Troubleshooting	43 – 50
• Cuts Slow, Cuts Rough, or Won't Hold an Edge	43 – 45
• Cutters or Tie-Straps Wear Heavily or Break	46
• Drive Links Wear Heavily or Break	47 – 48
• Sharpening Drive Link Tangs	49
• Saw Chain Has Tight Joints	49
• Saw Chain Cuts Crookedly/Leans to One Side/Cuts Unevenly	50

Guide Bars

Understanding Bar Part Numbers	53
Guide Bar Types	54 – 55
Bar Noses	56
Guide Bar Mount Types and Drive Sprocket Tooth Counts	56 – 70
• .404"-Pitch Guide Bar Mounts	57– 61
• .404"-Pitch Jet-Fit® Guide Bar Mounts	62 – 63
• 3/4"-Pitch Guide Bar Mounts	64 – 78
• 3/4"-Pitch Symmetrical Two-Ended Guide Bar Mounts	73
• 3/4"-Pitch Asymmetrical Double-Ended Mounts	74 - 75

Guide Bar Maintenance

Basic Guide Bar Maintenance Tasks	77 – 78
Replacing Nose Sprockets on HS Harvester Guide Bars	79 – 80
Replacing Nose Sprockets with Replacement Nose Kits on RH, SM, and SN Harvester Guide Bars	81-82

Guide Bar Troubleshooting

Guide Bar Rail Conditions	83 – 86
Guide Bar Nose Conditions	87 – 88
Guide Bar Mount Conditions	89
Jet-Fit® Guide Bar Mount Conditions	90

Drive Sprockets

Drive Sprocket Types	91-93
HarvesterLok® Information	93
Common Drive Shaft Configurations – .404"	94
Drive Sprocket Alignment	95-96
Troubleshooting Drive Sprockets	97
Hydraulic Pump Information	98
Notes	99-101

Key Safety Information

Chain Shot

⚠ WARNING: There is risk of serious injury or death to the machine operator, ground personnel and bystanders from chain shot. A Chain Shot Event (CSE) occurs when a piece or pieces of cutting chain from the end of a broken saw chain in mechanized timber harvesting or processing is ejected at a high velocity. Chain shot typically originates near the drive end of the cutting system but can also originate from the guide bar tip area. Saw chain pieces usually travel in the cutting plane of the guide bar, but can deviate to either side (see illustration below). Although the "Shot Cone Zone" reflects the most likely chain shot path, deflections can occur, substantially expanding where chain pieces may travel. To minimize risk, operators should keep out of the Shot Cone Zone, ground personnel and bystanders should be at least 230 feet away from cutting operations and out of the Shot Cone Zone.

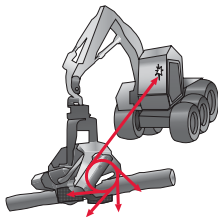

How Chain Shot Happens

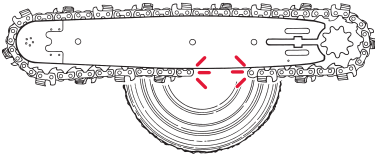

1. The saw chain breaks

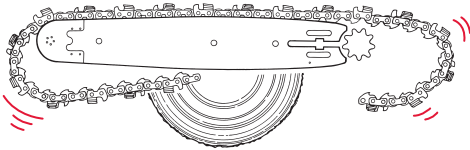

2. After a saw chain break, the “free” end of the saw chain begins to whip away from the break.

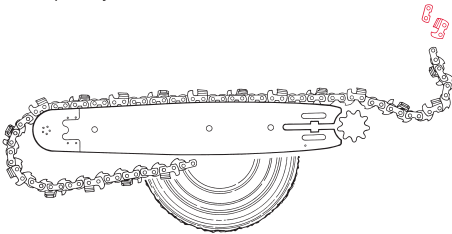

3. If the saw chain is not contained by the saw box or a chain shot guard, the broken saw chain’s free end can speed up rapidly, carrying immense dynamic energy.
4. At the peak of the whip, saw chain pieces may break loose and be ejected at high speed.

Important Safety Information

Minimizing the Risk of a Chain Shot Event

To minimize your risk of a chain shot event:

- You should follow the recommendations of your equipment manufacturer and those contained in this handbook.
- Your machine should be equipped with appropriate window enclosures, chain catchers, chain shot guards, and snow holes (shielded or closed) near the cutting system on the saw box.

Never use saw chain that has:

- Broken, cracked, or damaged components.
- Excessive saw chain stretch.
- Loose rivet joints (if the rivet rotates, the joints are too loose).

Operator, Ground Personnel, and Bystander Safety

- Never engage in a cut with yourself, ground personnel, or bystanders in the Shot Cone Zone (see pages 1 for complete illustration).
- Always cut as close to the ground as possible to reduce the distance that any potential ejected pieces could travel.

Guards and Shields

- Equipment should be equipped with appropriate guards, shields, and window enclosures to minimize the exposure of the operator, ground personnel, and bystanders to the cutting plane and Shot Cone Zone of the cutting system.
- Ground personnel and bystanders should comply with the setback requirement defined by your equipment manufacturer (at least 230 feet or 70 meters).

Important Safety Information

Windows

- The glazing of the operator's enclosure window should comply with local codes for impact resistance. The glazing should be replaced if any scratches (or other damage) obstructs the operator's effective viewing of the cutting operation.
- It should be noted that the UV portion of the light spectrum degrades the properties of polycarbonates (i.e. through time your protection decreases). Consult your equipment manufacturer or replacement glazing supplier for recommended replacement interval.
- Before upgrading, always check with your equipment manufacturer as it may change the operational integrity of the operator enclosure.

Cutting System

A saw chain based cutting system is composed of a drive sprocket, guide bar, and a loop of saw chain.

- The illustration below is a representation of the drive end of a cutting system and how the chain catcher and chain shot guard interrelate.
- Every equipment operator should be aware of the safety equipment that should always be present in the saw box. Consult your equipment manufacturer if any of these devices appear damaged or are missing.

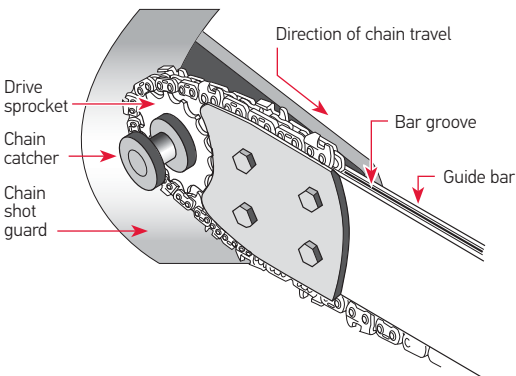

Important Safety Information

Chain Catcher

A chain catcher prevents a saw chain that has escaped from the bar groove from being “thrown” from the saw box. Chain catchers resemble a sturdy spool and are placed in line with the drive sprocket. A small gap on one side of the chain catcher allows installation and removal of the saw chain.

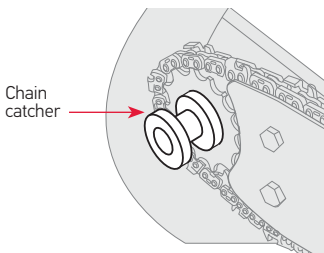

Chain Shot Guard

A chain shot guard is a piece of material mounted behind the drive sprocket; it performs two functions:

1. It absorbs the energy of a broken saw chain coming into contact with the saw box, reducing the risk of ejected parts during a chain shot event.
2. It acts as an extension of the saw box, reducing the risk of a thrown loop of saw chain (or saw chain parts) escaping the saw box.

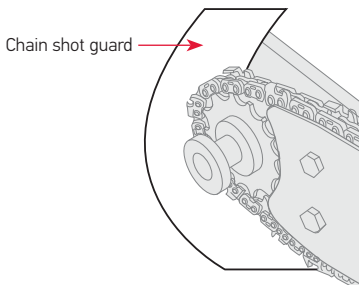

Operational Recommendations

Operational Recommendations

Cutting Systems Operational Parameters, Service Life, and Safety.

Recommendations for saw chain speed and guide bar feed load (listed in our Technical Data tables) are intended to provide a balance between performance and cutting system life.

⚠ WARNING: Exceeding recommendations may result in cutting system wear and shorter service life. Exceeding recommendations may increase the potential for chain shot events and potential injury or death. At no time should you exceed recommended maximum chain speed.

Technical Data (English Units)

Oregon Saw Chain Part Number	.404" Pitch		3/4" Pitch	
	18HX	19HX	11BC	11H

Operating Parameters

Guide bar/saw chain oil				
oz./cut	0.1	0.1	0.4	0.4
Power, hp min/max	5/65	20/65	5/90	10/100
Force on guide bar to tension saw chain, lbs.	110	110	150	150

Guide Bar Feed Load, at Center, lbs.

Min/max	30/200	30/200	30/300	30/300
Recommended	150	150	200	200

Saw Chain Speed, Ft./Min

Min/max	3000/8000	3000/8000	1500/7000	1500/7000
Recommended	8000	8000	6000	6000

Operational Recommendations

Technical Data (Metric Units)

Oregon Saw Chain Part Number	.404" Pitch		3/4" Pitch	
	18HX	19HX	11BC	11H
Operating Parameters				
Guide bar/Saw chain oil				
mL/cut	3	3	10	10
Power, at saw motor kW min/max	5/50	15/50	5/65	5/75
Force on guide bar to tension saw chain, N	490	490	668	668

Guide Bar Feed Load, at Center, N

Min/max	100/900	100/900	100/1300	100/1300
Recommended	700	700	900	900

Saw Chain Speed, m/sec

Min/max	15/40	15/40	10/35	10/35
Recommended	40	40	30	30

Lubrication

Your cutting systems operates in challenging environments and depend on sufficient lubrication to minimize wear and extend the life of operation.

Both bar and chain oils and grease can provide adequate lubrication to the cutting system when used correctly.

When using grease, ideal settings can vary based on temperature and other work-site conditions. Always begin by consulting your manufacturer's recommendations.

Regular inspection of your cutting system will let you know if any adjustments are needed.

- Both hydraulic fluid and used motor oil are not approved lubricants and their use can the warranty of your cutting system.
- Hydraulic fluid does not provide sufficient properties for preventing wear of your cutting system.
- Used oils may contain acidic compounds and abrasive particles that can compromise the cutting system's effectiveness and increase wear.

Operational Recommendations

At startup:

- Adequate time must be allowed for your lubrication to reach your cutting system.

In cold weather, or when using a new guide bar or saw chain, your system will require additional time. Follow these guidelines:

- Run the saw chain slowly while cycling the guide bar until lubricant can be observed leaving the tip of the guide bar.
- With oil-based lubrication systems, ensure a fine screen is installed in the fill port to minimize debris.
- Use a light/winter-weight lubricant. If possible, increase your per-cut flow rate.
- Some oiling systems can actually deliver less oil when the control is simply “turned up,” beyond a certain point. This is especially the case with fixed displacement, frequency/pulse type systems.
- If the pulses are set to occur too frequently, it is possible that the oil doesn't have a chance to flow into the pump cylinder before it is cycled.
- If your equipment has this type of system, always visually verify correct lubrication on the cutting system after making changes.
- Periodically cycle the cutting system without cutting (air cuts) in order to increase the amount of lubricant present and to ensure the system is working.

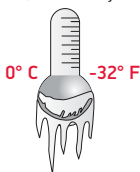

Chain Tension

Exceeding recommendations will shorten your cutting system's life of operation.

The recommended amount of force applied by the guide bar to tension saw chain:

- .404"-pitch saw chain is 110 pounds (490 N).
- 3/4"-pitch saw chain is 150 pounds (668 N).

Operational Recommendations

Manual Tensioning Systems

- Saw chain should be tight enough to pull the chassis of the saw chain firmly against the perimeter of the guide bar.
- Tension needs to be checked regularly.
- Only tension saw chain when it is cool. Steel expands when hot and contracts as it cools. As a result, it could cause damage to your guide bar or saw motor if tensioned when hot.
- At shut down or breaks, relieve saw chain tension to prevent damage to the cutting system (saw motor, bar tip, saw chain chassis) as the saw chain cools and contracts.
- In cold weather, maintain proper tension. Check tension often with manual tensioning systems.

Checking Tension

To check for proper tension, grasp the saw chain at the mid-span of the guide bar and pull the saw chain away from the bar rails.

- For **hard nose guide bars**, the drive link tangs should nearly come out of the bar groove.
- For **sprocket nose guide bars**, the saw chain chassis should come out of the bar groove/away from the bar rails approximately 1/8 inch (approximately 3 mm). When released, the chassis should snap back against the bar rails.

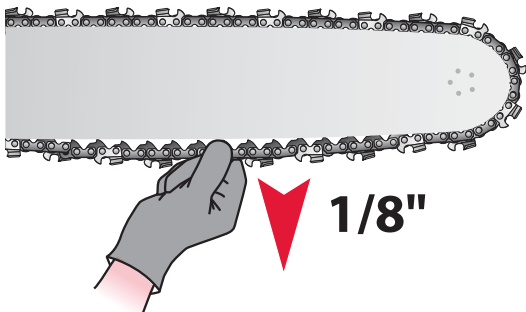

Operational Recommendations

Automatic Tensioning Systems

An automatic tensioning system is the most effective means to keep proper saw chain tension, especially if it is designed to compensate for the saw chain's high speed around a guide bar (the saw chain will lengthen as its speed increases).

The system can be optimized to respond to the changing loop length as your saw chain goes from rest, to full speed, to rest. As your saw chain speeds up, your guide bar will need to move forward to maintain proper tension. Otherwise, tension will decrease as much as 50 percent and can result in a thrown loop of saw chain. As your saw chain slows to a rest, the chain will decrease in length, and the guide bar will need to move back. Otherwise, the excessive tension will potentially damage your cutting system.

Refer to our Technical Data Tables (page 7) for the recommended amount of force applied to the guide bar to properly tension your saw chain.

Operational Recommendations

Saw Chain Allowable Spindle RPM

Drive Sprocket Teeth	RPM (.404" Pitch)	RPM (3/4" Pitch)	
	Maximum	Recommended	Maximum
7	-	6500	7600
8	-	5700	6700
9	13100	5100	5900
10	11800	4500	5300
11	10700	4100	4800
12	9800	3800	4400
13	9000	3500	4100
14	8400	3200	3800
15	7800	3000	3500
16	7300	-	-
17	6900	-	-
18	6500	-	-
19	6200	-	-
20	5900	-	-
21	5600	-	-
22	5300	-	-

- Recommended and Maximum .404" saw chain speed:
8000 ft/min (40.64 m/s)
- Recommended 3/4" saw chain speed:
6000 ft/min (30.48 m/s)
- Maximum 3/4" saw chain speed:
7000 ft/min (35.56 m/s)

Operational Recommendations

Installation and Break-In

The critical time for saw chain occurs during the break-in period for a new (or newly sharpened) saw chain.

We recommend transporting your new (or newly sharpened) saw chain to the job site in a container with lubricant. Leave them in the container until they are needed.

- If you do not transport your saw chain as suggested above, then lubricate your saw chain prior to use.

After installation, increase the saw speed gradually for the first 2 to 4 minutes of running while cycling the guide bar. Do this until you observe lubricant leaving the tip of the guide bar.

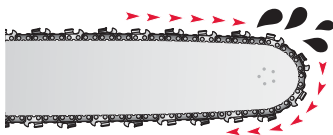

For manual tensioning systems, check and adjust as necessary.

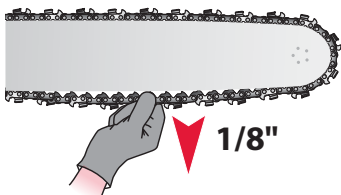

Best Practices

Daily Inspections

Check your safety devices at least once per shift :

- Chain shot guard
- Chain catcher
- Shields on snow holes
- Windows
- Cutting system

Run chain and guide bar in sets to equalize wear across the cutting system.

Replacement Schedule

.404" Pitch

- 1-2-10 (1 drive sprocket, 2 guide bars, 10 loops of saw chain).

3/4" Pitch

- 1-2-6 (1 drive sprocket, 2 guide bars, 6 loops of saw chain).

Use Sharp Chain

Replace saw chain at least once or more per shift. Maintaining sharp chain on the cutting system will pay off in many ways:

- Sharp chain cuts faster.
- Less energy (pressure and time) overall is used to complete a cut, so wear on the entire cutting system is reduced.

A slightly dull chain can be lightly sharpened instead of needing to be ground back significantly. It is best to lightly sharpen a slightly dull chain often to provide more and faster cuts.

Replace the saw chain at least once per shift. This can vary significantly with the type of timber being cut, the terrain, and other environmental factors.

If the cuts are getting slower, it's worth the time to get out of the cab and exchange the chain for a sharp one.

Operational Recommendations

 **WARNING:** There is risk of serious injury or death to the machine operator, ground personnel and bystanders from chain shot. Do not exceed our recommendations for saw chain speed, feed-force, lubrication, tension, and maintenance.

Cutting Safety

- Ensure you and all other personnel are clear of the Chain Shot Zone (see pages 1).
- Always cut as close to the ground as possible. This should reduce lubricant mist and wood chip dust on the cab and radiators, reduce timber cracking during cut-to-length processing, and reduce the range of any broken cutting system components.

Notice: Following these best practices consistently will increase your safety and the life of your cutting system.

Saw Chain



Saw Chain

Terminology

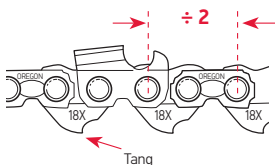

Saw Chain Pitch

Saw chain pitch is the distance between any three consecutive rivets, divided by two. Oregon Harvester saw chain is available in both .404" and 3/4" pitch.

Saw Chain Gauge

Saw Chain Gauge is the term used to describe the thickness of the drive link tang, which fits into the groove of the guide bar.

Oregon Harvester saw chain gauges are:

- 0.080" (2.0 mm)
Oregon has an 18X or 19X stamped on the drive link tang.
- 0.122" (3.1 mm)
Oregon has an 11 stamped on the drive link tang.

Ensure you use the correct recommendations for your saw chain (refer to the tables that follow).

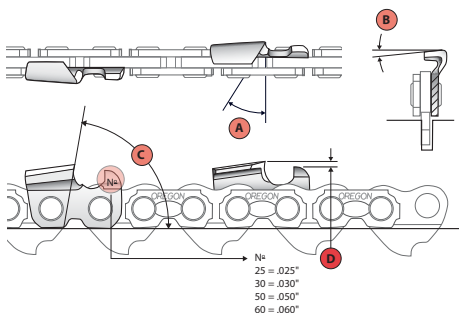

A. Top plate angle
B. File guide angle

C. Top plate cutting angle
D. Depth Gauge Setting

Parts of a Cutter

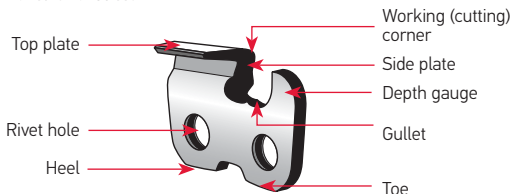

Parts of a Saw Chain

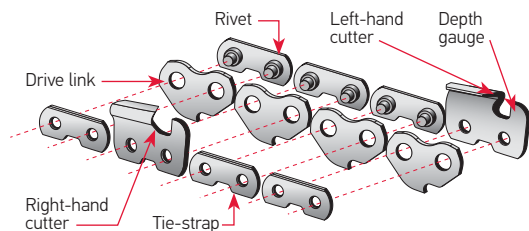

How a Cutter Works

Understanding how cutters work can help you realize why proper saw chain maintenance is so important.

1. The depth gauge rides on the wood and controls the bite of the working corner.

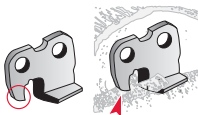

2. The working corner and side plate sever the wood fibers across the grain.

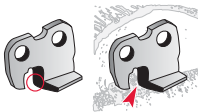

3. The top-plate cutting angle chisels out the severed wood fibers, lifting them up and out of the kerf.

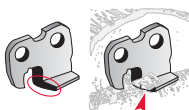

Oregon® Harvester Saw Chain

18HX – Harvester Saw Chain, Micro Chisel® – .404"

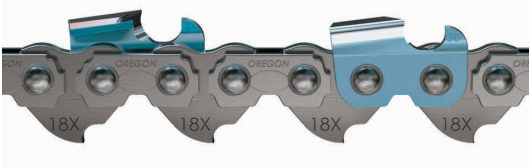

Features and Benefits

- Micro Chisel cutters have small-radius working corners for excellent performance and ease of maintenance.
- Patented saw chain steel that provides greater durability, especially in cold cutting conditions.
- Blued cutters provide superior corrosion resistance and improved strength.
- Wider, tougher coined drive links are thicker above the groove for increased strength.
- Larger rivets for reduced saw chain stretch.
- Wider kerf for reduced guide bar binding.
- LubriTec™ tie-straps help keep oil where it's needed – on the saw chain.

No.	Gauge	Pitch	Standard Sequence
18HX	.080" 2.0 mm	.404"	

Oregon® Harvester Saw Chain

Micro Chisel®
Cutter

End View

Harvester ONLY



File

File

File
Guide

Depth
Gauge

5-3/4"
Grind
Wheel

4-1/8"
Grind
Wheel

70502

12211

31686

38850

OR534-316

OR4125-316

596397 Harvester multi-purpose tool



|←X→|

A

B

C

D



7/32"



35°



10°



80°

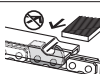

.050"
1.27 mm



3/16"



35°



10°



60°

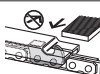

.050"
1.27 mm

Saw Chain

Oregon® Harvester Saw Chain

19HX – Harvester Saw Chain, Chamfer Chisel™ – .404"



The 19HX chain is optimized for modern high-flow, high-power heads¹ and saw motors for faster cutting speed. It features tall chamfer chisel cutters that combine best-in-class durability with improved chip clearance, to deliver faster and more consistent cuts in all types of wood.

Features and Benefits

- A new, taller and more aggressive chamfer chisel cutter is designed to deliver faster cutting speed compared to 18HX.
- Oregon's largest and thickest .404" components are designed to provide improved strength and superior durability compared to 18HX.
- Patented saw chain steel that provides greater durability, especially in cold cutting conditions.
- Blued cutters provide superior corrosion resistance and improved strength.
- Recommended for use with rim-type sprockets only.

No.	Gauge	Pitch	Standard Sequence
19HX	.080" 2.0 mm	.404"	

¹Note: Operating Parameters for this chain requires a minimum of 20 horsepower.

Oregon® Harvester Saw Chain

Chamfer Chisel™
Cutter

End View

Harvester ONLY



File

File

File
Guide

Depth
Gauge

5-3/4"
Grind
Wheel

4-1/8"
Grind
Wheel

70502

12211

31686

38850

OR534-316

OR4125-316

596397 Harvester multi-purpose tool



|←X→|



7/32"



35°



10°



80°



.050"
1.27 mm



3/16"



35°



10°



60°

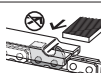

.050"
1.27 mm

Saw Chain

Note: The use of any other than Oregon 19HX part numbers for repair or joining loops is not approved and voids the product warranty. The effectiveness and durability of a chain loop assembled with anything other than these genuine and approved replacement parts cannot be guaranteed and is the responsibility of the those servicing the chain.

Oregon® Harvester Saw Chain

11H – Harvester Saw Chain, Semi-Chisel – 3/4"



Saw Chain



The 11H semi-chisel cutter features more aggressive design for maximum performance on more powerful machines.

Features and Benefits











- Semi-chisel cutters make 11H an aggressive, high-performance saw chain.
- Tested, proven chassis delivers superior strength and outstanding durability.
- Patented saw chain steel that provides greater durability, especially in cold cutting conditions.
- Advanced chrome plating process for excellent stay-sharp and edge-holding durability.
- 11H cutters are designed for longer stay-sharp, and feature an offset footprint to help minimize guide bar “knife-edging.”

No.	Gauge	Pitch	Standard Sequence
11H	.122" 3.1 mm	3/4"	

Oregon® Harvester Saw Chain

Semi-Chisel		End View		Harvester ONLY	
					
File	File	File Guide	Depth Gauge	5-3/4" Grind Wheel	4-1/8" Grind Wheel
90410	12211	107529	26800	OR534-316	-

533700 Harvester multi-purpose tool

	←X→	A	B	C	D
					
	5/16"	30°	0°	80°	.060" 1.52 mm
	5/16"	30°	0°	80°	.070" 1.78 mm
	←X→	A	B	C	D
					
	5/16"	30°	0°	50°	.060" 1.52 mm
	5/16"	30°	0°	50°	.070" 1.78 mm

11H cutters are set to .060" / 1.52 mm at the factory and should be left at those settings for cold cutting conditions. In other conditions, .070" / 1.788 mm will yield better cutting performance.

Oregon® Harvester Saw Chain

11BC – Harvester Saw Chain, Chipper – 3/4"



Saw Chain

11BC is a big 3/4"-pitch .122"-gauge saw chain, built for mechanical harvester/processor applications. Features classic chipper-style cutters.

Features and Benefits

- Chipper cutters have fully rounded working corners and side plates for a big, aggressive bite, easy sharpening, and edge-holding durability.
- Tested, proven chassis delivers superior strength and outstanding durability.
- Patented saw chain steel that provides greater durability, especially in cold cutting conditions.

No.	Gauge	Pitch	Standard Sequence
11BC	.122" 3.1 mm	3/4"	A diagram illustrating the standard sequence of the 11BC saw chain. It shows a repeating pattern of three red links followed by two grey links, representing the 3-2-3-2-3 sequence. The red links are chipper-style cutters, and the grey links are drive links.

Oregon® Harvester Saw Chain

Chipper

End View

Harvester ONLY



File

File

File
Guide

Depth
Gauge

5-3/4"
Grind
Wheel

4-1/8"
Grind
Wheel

90410

12211

31686

26800

OR534-316

-

533700 Harvester multi-purpose tool



|←X→|

A

B

C

D



5/16"



35°



0°



85°



.060"
1.52 mm



5/16"



35°



0°



60°



.060"
1.52 mm

Saw Chain

Saw Chain Maintenance

 **WARNING:** To reduce risk of injury, always use personal protective equipment (gloves and safety glasses) when handling saw chain.

Saw Chain Maintenance

Before sharpening, you should:

Clean

- Clean your saw chain, removing dirt, debris, and lubricant. This step is required before you inspect the chain.

Inspect

- In a well-lit area and using Oregon's Multi-Purpose Tool and Stretch Gauge, inspect your saw chain for Chain Stretch.
- Inspect for broken, cracked, damaged, or missing saw chain components.
- Inspect loose rivets. If you can turn a rivet with your fingers its loose.
- Inspect for excessive stretch, stretch is actually wear occurring to the flange of the rivet and the holes in your drive links.
- Inspect the chain chassis for abnormal wear patterns, which are indicators of other cutting system issues with the guide bar and drive sprocket.

Decide to Discard or Repair

Discard

Discard your saw chain when it has:

- Broken
- Broken and parts are missing
- Excessive stretch
- Loose Rivets

Saw Chain Maintenance

Repair

- Replace bent, cracked, or damaged saw chain components only when the proper tools and new components are available.
- When replacing damaged components, ensure the replacements match the worn components. New parts need to be filed to match the parts you're removing to ensure the chain's durability is not affected.

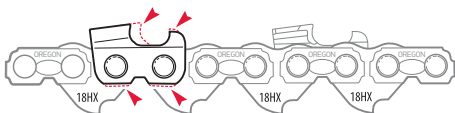

⚠ WARNING: Always use new components when repairing broken or damaged chains.

- Only use new Oregon components to replace Oregon damaged components. Never interchange components between manufacturers.

Clean and Lubricate

After grinding, chains should be cleaned to remove filing and grinding debris. After cleaning, lubricate, and or store in a container with lubricant.







Saw Chain Maintenance

Sharpening and Maintenance







See the following charts for more detail on sharpening angles.

Filing and Grinding Angles



		A	B	C	D
					
	18HX 7/32"	35°	10°	80°	.050" 1.27 mm
	19HX 7/32"	35°	10°	80°	.050" 1.27 mm
	11BC 5/16"	35°	0°	85°	.060" 1.52 mm
	11H 5/16"	30°	0°	80°	.060" 1.52 mm
	11H 5/16"	30°	0°	80°	.070" 1.778 mm



		A	B	C	D
					
	18HX 3/16"	35°	10°	60°	.050" 1.27 mm
	19HX 3/16"	35°	10°	60°	.050" 1.27 mm
	11BC 5/16"	35°	0°	60°	.060" 1.52 mm
	11H 5/16"	30°	0°	50°	.060" 1.52 mm
	11H 5/16"	30°	0°	50°	.070" 1.778 mm

Saw Chain Maintenance

Optional Sharpening Angles

Oregon provides a factory grind to suit a majority of our users, but we also provide the approved, alternative sharpening specifications that users may prefer for certain cutting conditions.

Cutting Conditions	A	B	C	D
18HX/19HX				
Factory	35°	10°	60°	.050" • 1.27 mm
Softwood	40°	20°	60°	.050" • 1.27 mm
Hardwood	35°	10°	60°	.050" • 1.27 mm
Frozen	40°	5°	60°	.040" • 1.02 mm
11BC				
Factory	35°	0°	60°	.060" • 1.52 mm
Softwood	35°	15°	60°	.060" • 1.52 mm
Hardwood	35°	0°	60°	.060" • 1.52 mm
Frozen	40°	0°	60°	.050" • 1.27 mm
11H*				
Factory	30°	10°	50°	.060" • 1.52 mm
Softwood	35°	20°	50°	.070" • 1.78 mm
Hardwood	30°	10°	50°	.070" • 1.78 mm
Frozen	25°	5°	50°	.060" • 1.52 mm

*For non-winter cutting conditions, the 11H depth gauge setting may be increased to 0.070" / 1.788 mm.

Saw Chain Maintenance

Sharpening and Maintenance Tools

710-120[†]
Standard



720-120[†]
All-in-One Auto Grinder



730-120^{†*}
Standard Auto Grinder



[†]Only available in USA.

*Sharpens 3/4" pitch only

620-120 (620-230)
Bench Grinder with
Hydraulic Assist



530-120H
3/4" Pitch
Bench Grinder



520-120 (520-230)
.404" Pitch
Bench Grinder



24548-SI
Heavy-Duty Chain
Breaker and Bar Nose
Rivet Driver



24549-SI
Heavy-Duty
Rivet Spinner



108742SI
Heavy-Duty Rivet Spinner
3/4" Pitch Rivet Spinner
Adaptor Kit



Saw Chain Maintenance

505033

Breaker Anvil for
Harvester Bar Noses



25049

Breaker Anvil
3/4" Pitch Saw Chain



533700

3/4" Pitch Harvester Multi-Purpose Tool



596397

.404" Pitch Harvester Multi-Purpose Tool



Saw Chain

Harvester Multi-Purpose Tool Functions

Bar Alignment Tool

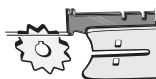

Bar Groove Cleaner



Bar Groove Depth

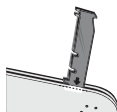

Bar Straightener



Grinding Wheel
Dress Gauge

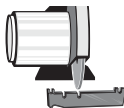

Chain Stretch Gauge

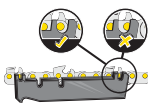

¹Plastic tool not intended for bar straightening. A retired chain section can be used for this purpose.

Saw Chain Maintenance



OREGON

18HX	31686	40458	-	70502	12211	38850	OR 534-316	596397
19HX	31686	40458	-	70502	12211	38850	OR 534-316	596397
11BC	107617	-	90410	-	12211	-	OR 534-516	533700
11H	107617	-	90410	-	12211	-	OR 534-516	533700

Note: The above products have different Part Numbers outside of North America.

File or grind to good chrome, removing all damage and keeping all cutter geometry equal, while following and not exceeding recommendations for angles and depth gauges settings.

Sharpening Saw Chain with a Round File

Using the correct file guide is the easiest way to maintain the saw chain because it always lays flat along the top plate. It keeps the file in the correct height location of 1/5th, or 20%, of the correct file's diameter above the cutter's top plate while helping you keep the correct top plate angle.

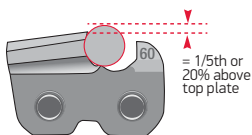

= 1/5th or 20% above top plate

Refer to the Filing Angles (pg. 31) or Optional Sharpening Modifications chart (pg. 32) for individual specifications.

1. Inspect the cutters of your loop of saw chain.
2. Begin filing on the chain's left or right-hand cutter with the most damage, sharpening all the cutters from one side of the chain at a time.



3. Be sure you remove all damage while keeping all geometries equal.

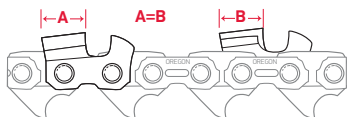

Saw Chain Maintenance

4. Always file from the inside of the chasis to the outside as shown below.

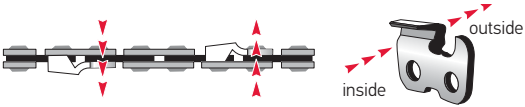

5. Repeat the process for the cutters on the other side of the chain, keeping all geometries equal and finishing all cutters from one side of your saw chain at the same time.

Sharpening Saw Chain with a Grinder

⚠ WARNING: To reduce risk of Injury, be sure to read your grinder's owner's manual for instructions on how to adjust settings, and don't forget to wear safety goggles.

Refer to the Grinding Angles (pg. 31) or Optional Sharpening Modifications chart (pg. 32) for individual specifications.

Setting the Vise Assembly

Set the vise assembly to the:

- Set the vise assembly to the recommended Top-Plate Angle A (see page 31) and Side-Plate Angle B (see page 31).
- Set the grinder head to the recommended Top-Plate Cutting Angle C. (See page 31.)

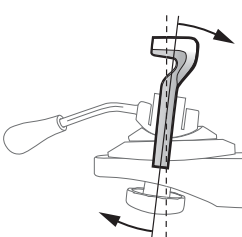
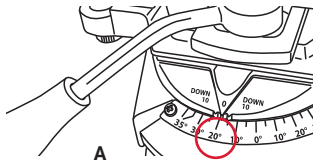

B

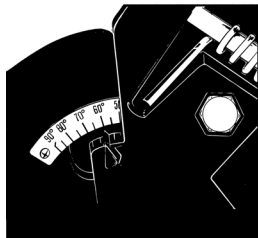

C

Saw Chain Maintenance

Grinding Wheels

⚠ WARNING: Grinding wheels can break. To reduce risk of injury, inspect for damage including cracks, and voids.

- Run Grinder for one minute before grinding.
- Keep tool guards in place.

No matter what kind of grinding wheel you use, be sure to keep it clean and well maintained.

Vitrified Grinding Wheels

Dress them often to maintain the correct shape using a rotary wheel dresser or a dressing brick.

For 11BC, 18HX, and 19HX use a full radius dress as seen below.

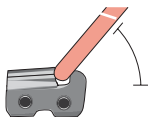
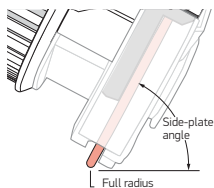

For 11H, use a modified radius and flat radius as seen below.

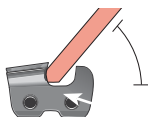
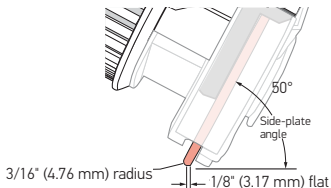

Saw Chain Maintenance

How to Set Depth Gauges

After filing or grinding, check and adjust depth gauges – depth gauges control the “bite” of your saw chain.

Using the correct depth gauge tool for your saw chain:

1. Place the tool on top of your saw chain so one depth gauge protrudes through the slot of the tool.

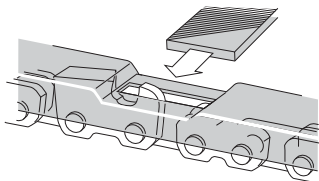

2. If the depth gauge extends above the slot, file it down with a flat file, filing from the inside of the cutter to the outside so that it is level with the depth gauge tool.

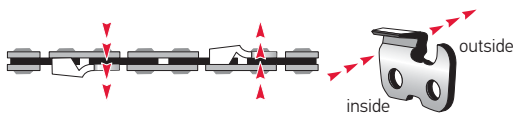

3. Never exceed recommended specifications. Doing so will negatively affect the life of operation and increase the potential for a chain shot event.

Saw Chain Repair

How to Break Out Rivets

 **WARNING:** To reduce risk of injury, wear eye protection and gloves.

1. Determine the appropriate anvil and anvil slot for the pitch of your saw chain.
2. Insert the saw chain to be broken into the proper slot of the anvil, then push it forward until the bottom tie-strap is flush with the far side of the anvil slot.
3. Drive links should be supported on both sides of the slot, as shown.
3. Insert the portion of the saw chain for breaking into the proper slot of the saw chain anvil and push saw chain forward until the bottom tie-strap is flush with the far side of slot. (The drive link will then be supported on both sides of the slot.)
4. Position the rivet head directly under the punch. When breaking the saw chain at a cutter, **make sure the cutter is in the top position on an anvil as shown below.**

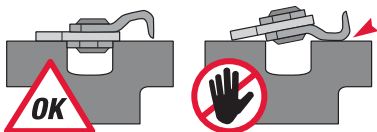

5. If you are using a bench model chain breaker, pull the handle of the chain breaker down. If you are using a handheld punch, center the punch on the rivet head and strike the punch. In either case, do not use excessive force.

Joining Saw Chain

Only use NEW Oregon replacement parts that are the correct size and type to join and repair Oregon saw chain. Oregon replacement parts are not designed for use in other manufacturers' saw chain.

- Joining a loop of saw chain at a cutter is not recommended; only join your saw chain at a tie-strap location.
- The rivet head must be snug and secure while allowing all joined parts to move freely.
- For best results with Oregon Harvester Saw Chain, we recommend using the Oregon Heavy-Duty Rivet Spinner to spin the chains. Consult with your local Oregon dealer to acquire a Heavy-Duty Rivet Spinner (24539-SI).



1. Place the preset tie-strap on a flat outer surface of a saw chain breaker anvil. Be sure the rivets are pointing up.

- a. Do not use a hammer to form rivet heads for Oregon .404"-pitch harvester saw chain.

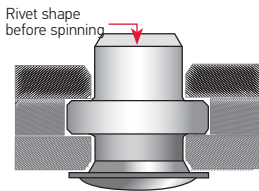

- b. For Oregon 3/4"-pitch harvester saw chain, it is recommended to strike the rivet once after assembly before spinning. Make sure to only strike the rivet.

Properly formed rivet head

2. If you're replacing a cutter, break at the tie-strap location in front of and behind the cutter you're replacing.



Saw Chain Repair

- Cutter and tie-strap replacement parts should be filed back to match the existing chassis parts as shown below.

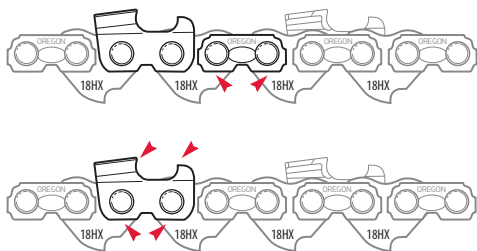

- Place the preset tie-strap on a flat outer surface of a breaker anvil with the rivets pointing up.

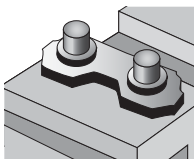

- Assemble the saw chain to the preset tie-strap.

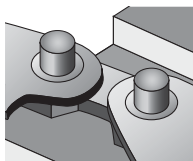

- Assemble the tie-strap with brand mark or dot face up and the notch toward the drive link tangs.

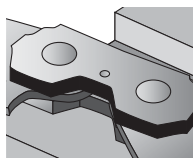

Additional Chain Joining Instructions

Follow these instructions to join your Harvester saw chain with the rivet spinner:

1. For Oregon .404"-pitch Harvester Saw Chain (18HX, 19HX), use take up handle "A" and anvil "A". Do not use a hammer to assemble.
2. For Oregon 3/4"-pitch Harvester Saw Chain (11BC, 11H), use part number 108724. Strike the rivet with a hammer **once** to set the rivet in the tie-strap before being spun.
3. After spinning, tension and twist the chain with gloved hands, and look carefully for any relative movement between joined tie-straps and their rivets.
4. No relative movement is acceptable – if observed, the joint should be spun further.
5. Placing a drop of oil between the rivet head and the tie-strap before twisting can make it easier to see relative motion. The oil will visibly move with capillary action if there is even the tiniest separation between the parts.

Saw Chain Troubleshooting

Most Harvester saw chain problems are caused by:

- Excessive saw chain speed and/or feed force.
- Poor maintenance practices.
- Lack of lubrication or the use of poor quality lubricants.

Here are the things to look for and the associated corrective actions you should take:

Cuts slow, cuts rough, or won't hold an edge

Look closely at your saw chain's cutters and compare them to the following illustrations.



1. Light abrasive damage on side plates.

Cause: Cutters came in contact with light abrasive materials.

Symptoms: Very slow cutting

Remedy: File cutters back until all damage is removed.



2. Severe abrasive damage on side and/or top-plates.

Cause: Cutters hit or cut material other than wood, such as rock, dirt, or sand. This type of damage typically occurs when cutting close to the ground.

Symptoms: Saw chain won't cut or cuts crookedly if the damage is to one side of saw chain. Possible guide bar rail damage.

Remedy: File cutters back until all damage is removed.

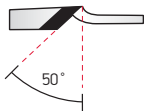

3. Too much top-plate filing angle.

Cause: Excessive top-plate angle while filing or grinding.

Symptoms: Cutting angle is very sharp, but dulls fast. Cutting action rough and erratic.

Remedy: Resharpen cutters while holding the file at the correct top-plate filing angle for the saw chain. Be sure the file guide is stamped with the saw chain's correct top-plate angle.

Saw Chain Troubleshooting

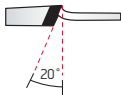

4. Too little top-plate filing angle.

Cause: Filed or ground at less than the recommended angle.

Symptoms: Slow cutting. Requires extra effort to cut. Possible binding in cut.

Remedy: Resharpen cutters while holding the file at the correct top-plate filing angle for the saw chain. Be sure the file guide is stamped with the saw chain's correct top-plate angle.

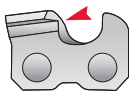

5. Too much top-plate cutting angle.

Cause: File held too low or file is too small.

Grinders: Saw chain ground at the wrong top-plate cutting angle or using an incorrectly-sized grinding wheel.

Symptom: Poor stay-sharp. Rapid dulling. Cuts fast for a short time, then dulls.

Remedy: Resharpen cutters with the correct file in the right size, held in the correct position. Use correct file guide.

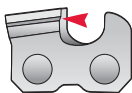

6. Too little top-plate cutting angle.

Cause: File held too high or file is too large.

Grinders: Saw chain ground at the wrong top-plate cutting angle or an incorrectly sized grinding wheel.

Symptoms: Slow cutting. Premature wear to saw chain and guide bar rails.

Remedy: Resharpen cutters using the correct file guide that is the right size and in the correct position.



7. Too much hook in the side plate.

Cause: File held too low or the file is too small.

Grinders: Saw chain ground at the wrong top-plate cutting angle, grinding wheel is too small or is grinding too deep into the body of cutter.

Symptoms: Rough cutting. Saw chain grabs. Cutters dull quickly or won't hold cutting edge. Top plate breakage and/or saw chain stretch.

Remedy: Resharpen cutters using the correct file in the right size held in the correct position.

Saw Chain Troubleshooting



8. Backslope on the side plate.

Cause: File held too high or the file is too large. Grinders: Saw chain ground at the wrong top-plate cutting angle, grinding wheel is too large, or the grinding wheel is not grinding deep enough into the body of cutter.

Symptoms: Slow cutting. Premature wear to saw chain and guide bar rails.

Remedy: Resharpen cutters using the correct file guide in the right size held in the correct position.

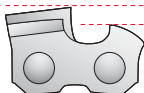

9. Low depth gauges.

Cause: Depth gauge never lowered.

Symptoms: Rough cutting. Saw chain grabs. Excessive wear to the heel of cutters, opposing tie-straps, guide bar rails. Top-plate breakage and/or saw chain stretch.

Remedy: In most cases, cutters cannot be filed back enough to correct for depth gauges that are too low. Replace the saw chain.

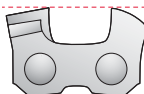

10. High depth gauges.

Cause: Too much depth gauge removed; depth gauge damaged in use.

Symptoms: Slow cutting. Excessive wear to the saw chain and guide bar rails.

Remedy: File depth gauges down to their correct height.

Note: See pages 31 – 38 for the proper filing techniques to use when applying the remedies above.

Saw Chain Troubleshooting

Cutters or tie-straps wear heavily or break.

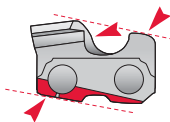

11. Excessive heel wear on cutters and opposite tie-straps; cracks under rear rivet holes.

Cause: Forcing dull saw chain to cut. Low depth gauge settings. Lack of lubrication. Loose saw chain tension.

Symptoms: Excessive heel wear on cutters. Saw chain breakage. Excessive saw chain stretch.

Remedy: Replace worn or cracked cutters and/or tie-straps. Sharpen cutters properly and often. Use proper saw chain tension and plenty of lubrication.

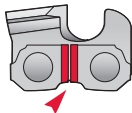

12. Tie-straps or cutters, broken in the center.

Cause: Incorrect field assembly of saw chain components.

Symptoms: Broken tie-straps or cutters.

Remedy: Replace broken components. See "Joining Saw Chain" on pages 40 – 42.

Be sure to spin chain joints precisely.

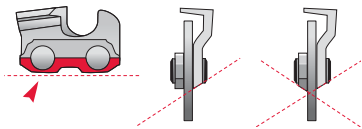

13. Bottoms of tie-straps and cutters worn out of square.

Cause: Worn guide bar rails.

Symptoms: Bottoms of tie-straps and cutters worn out of square.

Remedy: If saw chain is worn excessively, replace saw chain. If guide bar groove is too wide, replace guide bar. If rails are worn, dress top of guide bar to square. Maintain proper lubrication and saw chain tension. See "Guide Bar Troubleshooting" on pages 83 – 90.

Saw Chain Troubleshooting

Drive links wear heavily or break.

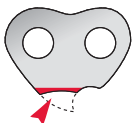
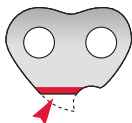

14. Straight or concave bottoms.

Cause: Straight bottoms are due to shallow guide bar body groove. Concave bottoms are due to shallow guide bar nose groove.

Symptoms: Drive link tangs worn straight or concave. Drive links can't clean guide bar groove. Tendency to throw saw chain from guide bar.

Remedy: Replace guide bar, drive sprocket or both. Sharpen drive links or replace entire saw chain if many drive links are damaged.

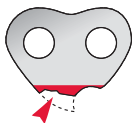

15. Battered and broken bottoms.

Cause: Worn or broken drive sprocket. Loose saw chain tension or saw chain jumping from guide bar groove. Results in damage from revolving drive sprocket.

Symptoms: Drive links are burred or nicked. Drive links may not fit in guide bar groove. Drive links can't clean the guide bar groove.

Remedy: Maintain proper tension to prevent saw chain from climbing out of the spur drive sprocket. Keep the guide bar groove clear of debris. Replace drive sprocket if worn. Replace drive links or replace entire saw chain if many drive links are damaged.



16. Peening in front or back.

Cause: Worn drive sprocket. Pin sprocket systems are known to concentrate load to the back of drive link, causing premature wear.

Symptoms: Change in drive link shape. Tight joints in the saw chain. Saw chain stretch. Shortened saw chain life.

Remedy: Replace the drive sprocket and/or pins. Replace saw chain. Do not attempt to run a new saw chain on an old drive sprocket, or an old saw chain on a new drive sprocket.

Saw Chain Troubleshooting

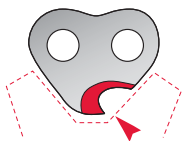

17. Drive link tang turned up.

Cause: Worn drive sprocket.

Symptoms: Drive link tangs hit the bottom.

Remedy: Replace drive sprocket, sharpen drive link tangs (as shown in **Sharpening Drive Link Tangs**; see page 49) if possible, or replace the saw chain.

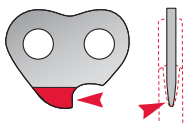

18. Sides worn round or thin at bottoms.

Cause: Guide bar rails have spread, or one rail has worn low, allowing saw chain to lean over. Improper sharpening angles. One side of saw chain dull. Use of .063" gauge saw chain in .080" guide bar.

Symptoms: Saw chain cuts crookedly. Accelerated guide bar rail and saw chain wear.

Remedy: Ensure guide bar and saw chain gauge match. Sharpen cutters frequently, using recommended angles. Have guide bar rails serviced by a dealer, or if possible, dress guide bar rails square. If guide bar groove is spread too wide, replace guide bar. If saw chain wear is extensive, replace the saw chain.

Saw Chain Troubleshooting

Sharpening Drive Link Tangs

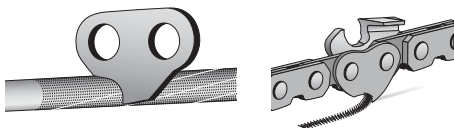

Pointed drive link tangs help remove chips and debris from your guide bar groove. Sharpen damaged tangs back to their original shape with a round file.

Saw chain has tight joints.

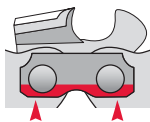

19. Peening on bottom or front of cutters and tie-straps.

Cause: Improper saw chain tension or a worn out drive sprocket.

Symptoms: Saw chain stretch or saw chain breakage.

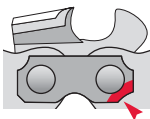

Remedy: Saw chain with tight joints cannot be repaired. Replace the saw chain and maintain proper tension. Replace the rim drive sprocket if worn.



20. Peening in notches of cutters and tie-straps.

Cause: Worn spur drive sprocket.

Symptoms: Saw chain stretch or saw chain breakage.

Remedy: Replace the spur drive sprocket. Replace the saw chain. Always maintain proper tension and do not run saw chain on a worn drive sprocket.

Saw Chain Troubleshooting

Saw chain cuts crookedly/leans to one side/cuts unevenly

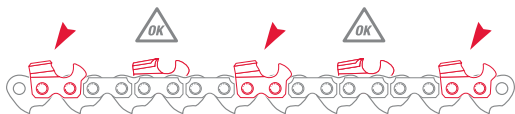

21. Damage to cutters on one side of saw chain.

Cause: Cutters on one side of saw chain are damaged by hitting the saw box or the ground/debris.

Symptoms: Guide bar and saw chain bind in the cut. Could result in guide bar and saw chain breakage when removing the guide bar from tree. Uneven guide bar rail wear.

Remedy: File cutters back enough to remove all damage. Square up guide bar rails if uneven.

Note: Prevent the bar from being bent and touching the saw box. Always make sure the felling cut is done before moving the harvester head with the crane.



22. Different cutter top-plate lengths

Cause: Inconsistent sharpening.

Symptoms: Guide bar and saw chain bind in the cut. Could result in guide bar and saw chain breakage when removing the guide bar from tree. Uneven guide bar rail wear.

Remedy: File cutters back to even cutter top-plate lengths. Square up guide bar rails if uneven.

Guide Bars

Solid Harvester

.404"

LubriTec
LUBRICATION

OREGON®

18HX

SpeedMax™ XL

.404" Harvester

LubriTec Jet-Fit
LUBRICATION

OREGON®

Guide Bars



Understanding Bar Part Numbers

Oregon bar part numbers are printed on the bar package, and have 10 digits. Here's what each digit means.

75 2 SM R L114

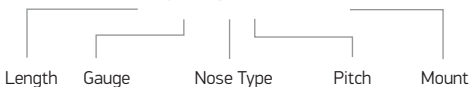

Length	Gauge	Nose Type	Pitch	Mount
.404				
cm	2	HS Solid Steel Sprocket-Nose .404"-pitch bar	F/R	B149 L163
42 73	.080"		.404"	B163 L172
45 74		HL Stump Spray Bar – LH		D104 L205
48 75		HR Stump Spray Bar – RH		D149 M104
54 80		RH Solid Steel Replaceable Sprocket-Nose		L003 M226
55 82				L104 N104
59 88		.404"-pitch bar		L114 N114
60 90		SM SpeedMax™ XL		L148 Q003
64 00 (100)				L149 Q104
65 13 (113)				Q114
67				Q149
				Q163
				R104
				R114
				R149
				S149
				S163
				Y104

3/4							
inch	1	SN	Solid Steel Replaceable Sprocket-Nose 3/4"-pitch bar	C	C159	T133	T221
18	39	122"		3/4"	C211	T138	T222
23	40			F212	T145	T223	
24	43			DE	Solid Steel Double-Ended 3/4"-pitch bar	A	G138
27	44			B	J134	T151	T227
28	45	UE	Solid Steel Unequal Ended 3/4"-pitch bar	C	J211	T152	T229
29	51			D	K205	T161	T230
30	52			X	K187	T168	V127
31	58			3/4"	K225	T177	9135
32	59			AT	Solid Steel Armor Tip 3/4"-pitch bar	V	P155
33	60			Very	P207	T208	9155
34	64			Large	T043	T210	9164
35	65			Radius	T130	T217	9191
36	66			3/4"	T132	T219	H175
37	77						
38							

Guide Bar Types: .404" Pitch

Solid Harvester Solid-Nose Bar HSF



Solid Harvester Replaceable Sprocket-Nose Bar RHF



Jet-Fit® Solid Harvester Sprocket-Nose Bar HSF



Jet-Fit® Solid Harvester Replaceable Sprocket-Nose Bar RHF



Stump Spray Solid Harvester Sprocket-Nose Bar HRF and HLF



SpeedMax™ XL Harvester Sprocket-Nose Bar SMR



Guide Bar

Guide Bars

Guide Bar Types: 3/4" Pitch

Harvester Sprocket-Nose Bar SNC



Harvester Sprocket-Nose Bar with Jet-Fit and Stump Spray SNC



Harvest Armor Tip Bar ATV



Double-Ended Slasher / Pond & Deck Bars DEA, DEB, DEC
Symmetrical







Asymmetrical Slasher / Pond & Deck Bars UEA, UEB, UED



.404" Pitch Guide Bar Mounts

Bar Noses: Solid and Replaceable Sprocket Nose

	Pitch and Tooth Count	Gauge	Part No.	Rivet Part No.
	.404" • 11T	0.080"	101918	529035*
	.404" • 11T	0.080"	537245	529035*
	.404" • 14T	0.080"	SMR14T	578147*
	3/4" • 9T	0.122"	40693A	525152*

* 25 Rivets per package

Guide Bar Mount Types and Drive Sprocket Tooth Counts

.404			3/4	
Drive Sprocket Tooth Count	Standard Mount Type	SpeedMax Mount Type	Drive Sprocket Tooth Count	Standard Mount Type
9 - 11	M		7-8	C, K
11-13	L	Q	8	J
13	Y		8 - 9	F
14-16	B, N	R	9 - 10	T, V
17-19	D	S	11-12	G

Double/Unequal Ender Bars

3/4		3/4	
Drive Sprocket Tooth Count	SpeedMax Mount Type	Drive Sprocket Tooth Count	Standard Mount Type
15	P	9	E
		21	H

.404" Pitch Guide Bar Mounts

D104

Drive sprocket
tooth count:
17, 18, 19

Dimensions:

- ① .394" x
3.338"
- ② .404" x
.555"

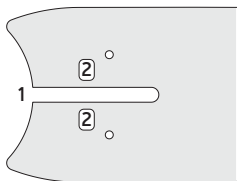

L003

Drive sprocket
tooth count:
11, 12, 13

Dimensions:

- ① .7/8"
(.875")
- ② .448"

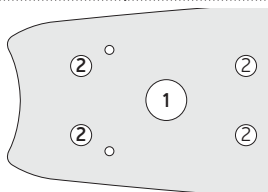

L104

Drive sprocket
tooth count:
11, 12, 13

Dimensions:

- ① .394" (10
mm) x
3.338"
- ② .555" x
.404"

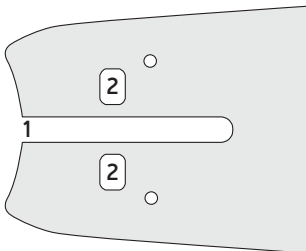

L114

Drive sprocket
tooth count:
11, 12, 13

Dimensions:

- ① .394" (10
mm) x
3.338"
- ② .555" x
.404"
- ③ .435"

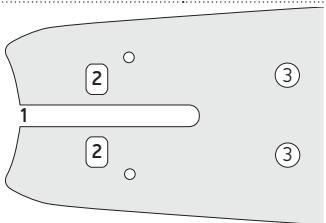

.404" Pitch Guide Bar Mounts

L148

Drive sprocket
tooth count:
11, 12, 13

Dimensions:

- ① .394" (10 mm) x 3.338"
- ② .555" x .404"
- ③ .435"

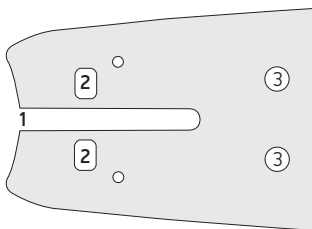

L205

Drive sprocket
tooth count:
11, 12, 13

Dimensions:

- ① .555" x .404"
- ② .640"

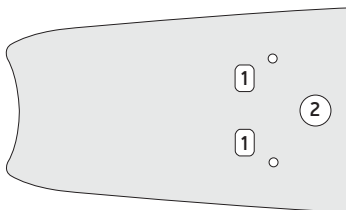

M104

Drive sprocket
tooth count:
9, 10, 11

Dimensions:

- ① .394" (10 mm) x 3.338"
- ② .555" x .404"

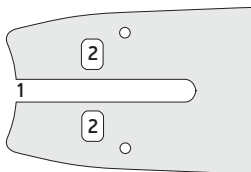

M226

Drive sprocket
tooth count:
9, 10, 11

Dimensions:

- ① .570" x 3.914"
- ② .311"

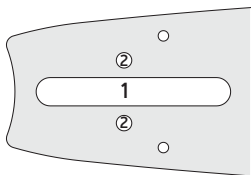

.404" Pitch Guide Bar Mounts

N104

Drive sprocket
tooth count:
14, 15, 16

Dimensions:

- ① .394" (10 mm) x 3.338"
- ② .555" x .404"

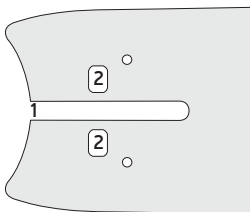

N114

Drive sprocket
tooth count:
14, 15, 16

Dimensions:

- ① .394" (10 mm) x 3.338"
- ② .555" x .404"
- ③ .435"

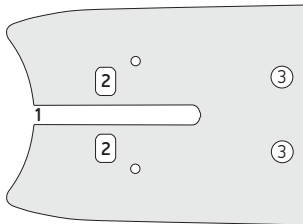

Q003

Drive sprocket
tooth count:
11, 12, 13

Dimensions:

- ① .448"
- ② .875"

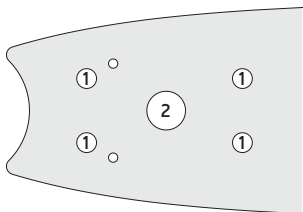

Q/R104

Drive sprocket
tooth count:
R: 11, 12, 13
Q: 14, 15, 16

Dimensions:

- ① .399" x 3.338"
- ② .404" x .555"

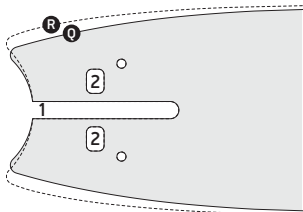

.404" Pitch Guide Bar Mounts

Q/R114

Drive sprocket

tooth count:

Q: 11, 12, 13

R: 14, 15, 16

Dimensions:

- ① .399" x 3.338"
- ② .404" x .555"
- ③ .435"

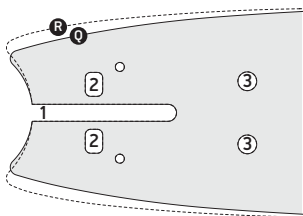

Q/S163

Drive sprocket

tooth count:

Q: 11, 12, 13

S: 17, 18, 19

Dimensions:

- ① .586" x 3.288"
- ② .413" x .696"

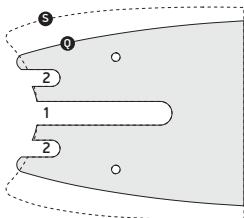

Q/R/S149

Drive sprocket

tooth count:

Q: 11, 12, 13

R: 14, 15, 16

S: 17, 18, 19

Dimensions:

- ① .586" x 3.288"
- ② .413" x .696"
- ③ .492"

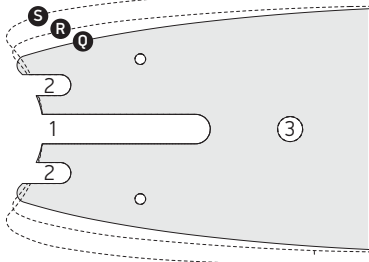

Y104

Drive sprocket

tooth count:

13

Dimensions:

- ① .394" (10 mm) x 3.338"
- ② .555" x .404"

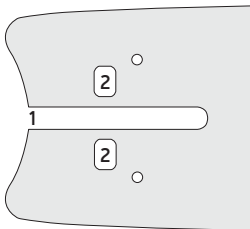

.404" Pitch Guide Bar Mounts

B149

Drive sprocket
tooth count:
14, 15, 16

Dimensions:

- ① .581" (15 mm) x 3.406"
- ② .413" x .848"
- ③ .492"

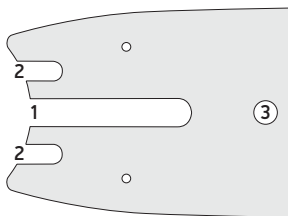

.404" Pitch Jet Fit Guide Bar Mounts

B163

Drive sprocket
tooth count:
14, 15, 16

Dimensions:

- ① .581" (15 mm) x 3.406"
- ② .413" x .838"

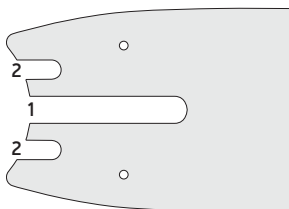

D149

Drive sprocket
tooth count:
17, 18

Dimensions:

- ① .581" (15 mm) x 3.406"
- ② .413" x .814"
- ③ .492"

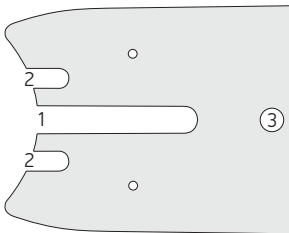

L149

Drive sprocket
tooth count:
11, 12, 13

Dimensions:

- ① .581" (15 mm) x 3.406"
- ② .413" x .814"
- ③ .492"

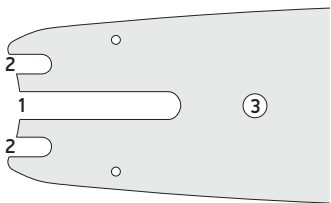

L163

Drive sprocket
tooth count:
11, 12, 13

Dimensions:

- ① .581" (15 mm) x 3.406"
- ② .413" x .814"

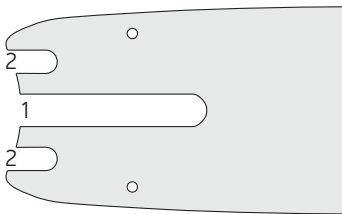

.404" Pitch Jet Fit Guide Bar Mounts

L172

Drive sprocket
tooth count:
11, 12, 13

Dimensions:

- ① .581" (15 mm) x 3.406"
- ② .413" x .814"
- ③ .492"

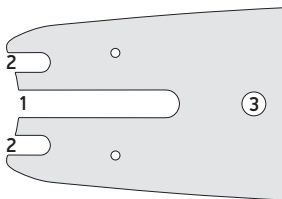

NOTE: Not interchangeable with L149 or L163 mounts

3/4" Pitch Guide Bar Mounts

C159

Drive sprocket
tooth count:
7, 8

Dimensions:

- ① .635"
x 4.502"
- ② .190"
radius
- ③ .151"
radius

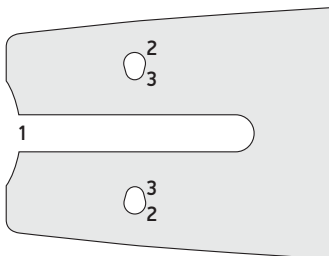

C211

Drive sprocket
tooth count:
7, 8

Dimensions:

- ① .394"
x 3.338"
- ② .404"
x .555"

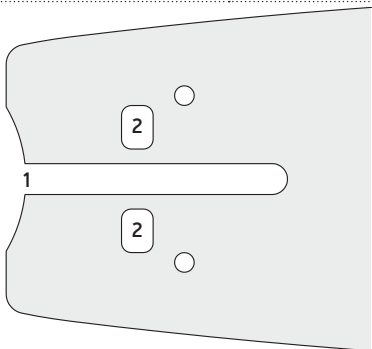

F212

Drive sprocket
tooth count:
8, 9

Dimensions:

- ① .640"
x 3.640"
- ② .313"
- ③ .313"
x .867"
- ④ .648"

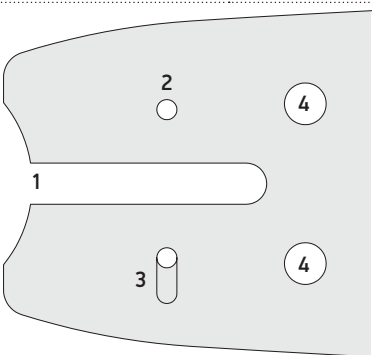

3/4" Pitch Guide Bar Mounts

G138

Drive sprocket
tooth count:
11,12

Dimensions:

① .635"
x 7.410"

② .650"

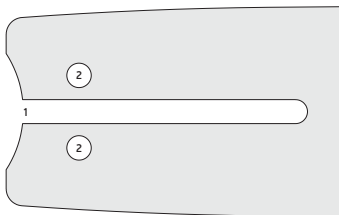

J134

Drive sprocket
tooth count:
8

Dimensions:

① .562"

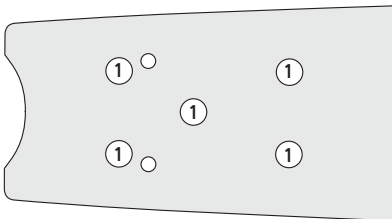

J211

Drive sprocket
tooth count:
8

Dimensions:

① .394"
x 3.338"

② .555"
x .404"

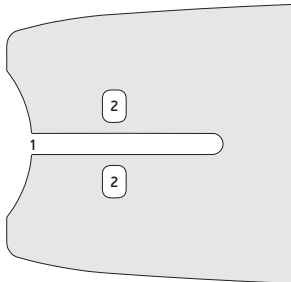

K177

Drive sprocket
tooth count:
7, 8

Dimensions:

① .625"
x 3.25"

② .306"

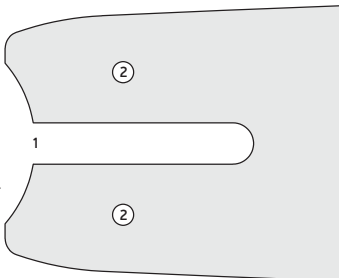

3/4" Pitch Guide Bar Mounts

K187

Drive sprocket
tooth count:
7, 8

Dimensions:

- ① .375"
x 2.966"
- ② .250"

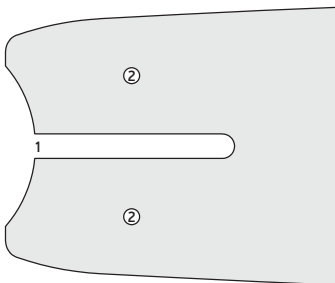

K205

Drive sprocket
tooth count:
7, 8

Dimensions:

- ① .645"
- ② .410"

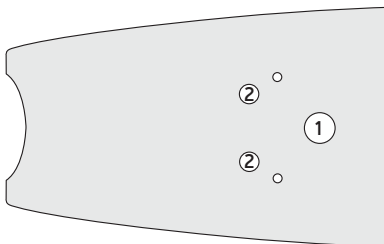

K225

Drive sprocket
tooth count:
7, 8

Dimensions:

- ① .581"
x 3.288"
- ② .413"
x .889"

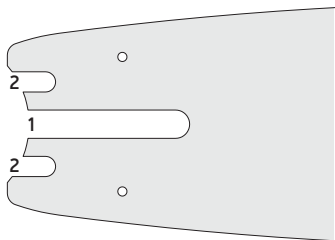

T043 RSN

Drive sprocket
tooth count:
9, 10

Dimensions:

- ① .609"
- ② .562"
- ③ .531"

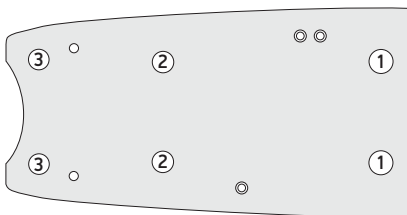

3/4" Pitch Guide Bar Mounts

T130

Drive sprocket
tooth count:
9, 10

Dimensions:

- ① .875" x
4.054"
- ② .531" x 3"

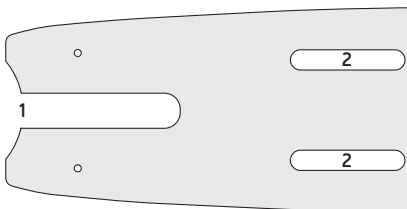

T132

Drive sprocket
tooth count:
9, 10

Dimensions:

- ① .531" x
3.064"
- ② .562"

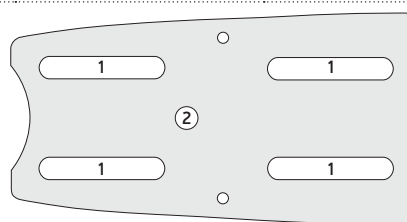

T133

Drive sprocket
tooth count:
9, 10

Dimensions:

- ① .515" x
4.129"
- ② .515"

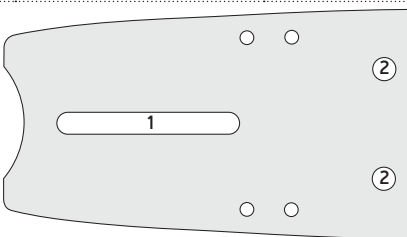

T138

Drive sprocket
tooth count:
9, 10

Dimensions:

- ① .635" x
7.410"
- ② .650"

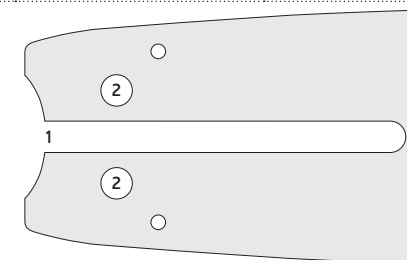

3/4" Pitch Guide Bar Mounts

T145

Drive sprocket
tooth count:
9, 10

Dimensions:

① .570"

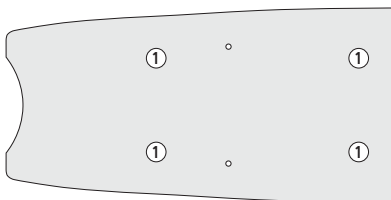

T146

Drive sprocket
tooth count:
9, 10

Dimensions:

① .637" x
3.627"

② .531"

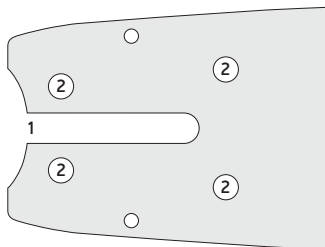

T151

Drive sprocket
tooth count:
9, 10

Dimensions:

① .535" x
3.226"

② .531"

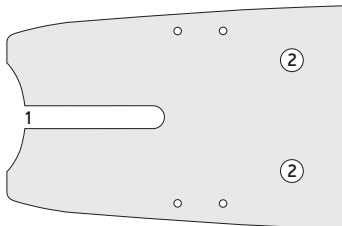

T152

Drive sprocket
tooth count:
9, 10

Dimensions:

① .760"
x 5.910"

② .562"

③ .531"

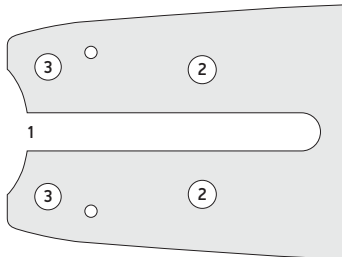

3/4" Pitch Guide Bar Mounts

T161

Drive sprocket
tooth count:
9, 10

Dimensions:

- ❶ .447"
x 5.500"
- ❷ .880" x
.568"
- ❸ .531" x
2.281"

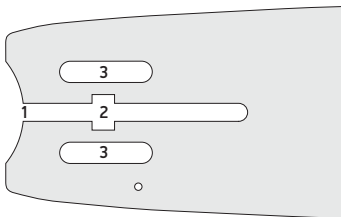

T168

Drive sprocket
tooth count:
9, 10

Dimensions:

- ❶ .609"
- ❷ .562"

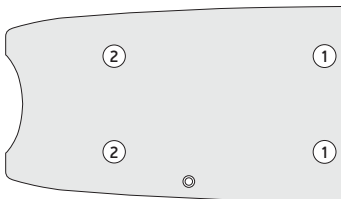

T177

Drive sprocket
tooth count:
9, 10

Dimensions:

- ❶ .625" x
3.25"
- ❷ .306"

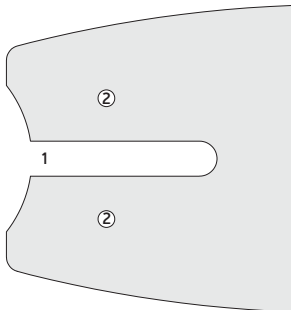

T190

Drive sprocket
tooth count:
9, 10

Dimensions:

- ❶ .760" x
5.25"
- ❷ .760"

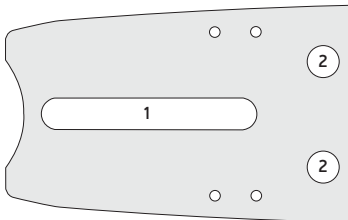

3/4" Pitch Guide Bar Mounts

T208

Drive sprocket
tooth count:
9, 10

Dimensions:

① .515"
x 4.129"

② .770"

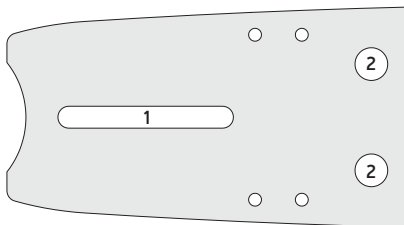

T210

Drive sprocket
tooth count:
9, 10

Dimensions:

① .782"

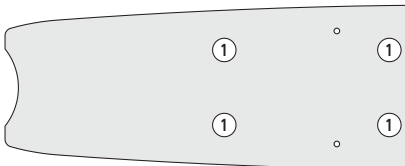

T217

Drive sprocket
tooth count:
9, 10

Dimensions:

① .787"
x 4.330"

② .512"

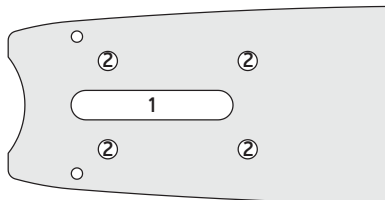

T219

Drive sprocket
tooth count:
9, 10

Dimensions:

① .635"
x 3.312"

② .151"
radius
x .190"
radius

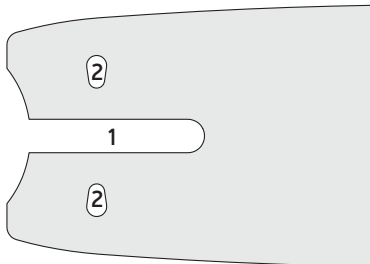

3/4" Pitch Guide Bar Mounts

T221

Drive sprocket
tooth count:
9, 10

Dimensions:

① .760"
x 4.374"

② .760"

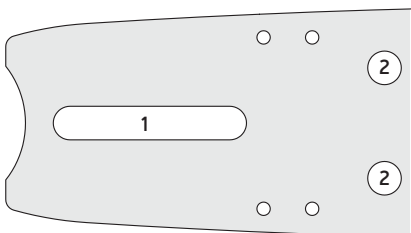

T222

Drive sprocket
tooth count:
9, 10

Dimensions:

① .679"

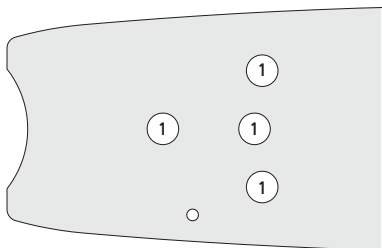

T223

Drive sprocket
tooth count:
9, 10

Dimensions:

① .679"

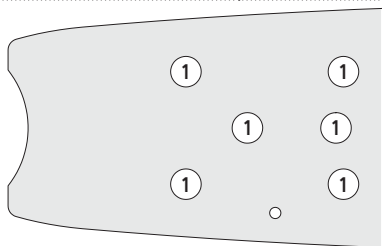

T224

Drive sprocket
tooth count:
9, 10

Dimensions:

① .630"

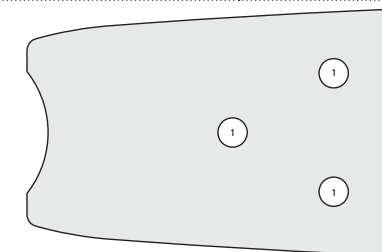

3/4" Pitch Guide Bar Mounts

T227

Drive sprocket
tooth count:
9, 10

Dimensions:

- ① .875" x 4.000"
- ② .500" x 1.196"

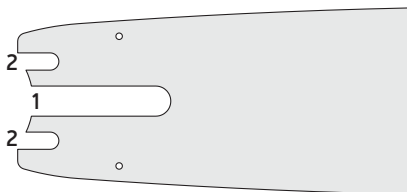

T229

Drive sprocket
tooth count:
9, 10

Dimensions:

- ① .880" x 7.584"
- ② .506" x 2.842"

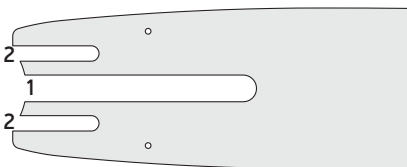

T230

Drive sprocket
tooth count:
9, 10

Dimensions:

- ① .562"
- ② .609"

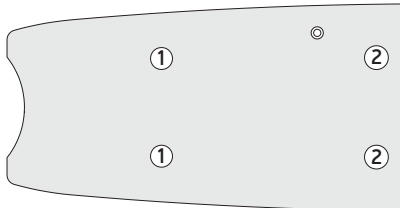

V127

Drive sprocket
tooth count:
9, 10

Dimensions:

- ① .812" x 2.577"
- ② .812" x 2.453"
- ③ .500"

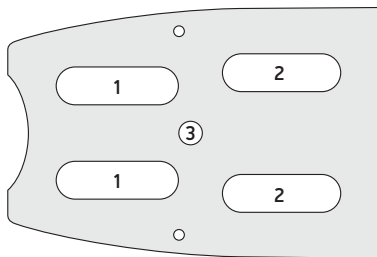

3/4" Pitch Guide Bar Mounts Symmetrical Double-Ended

9135

Drive sprocket
tooth count:
9, 10



Dimensions:

- ① .906" x 4.500"
- ② .531" x 3.000"
- ③ .375"

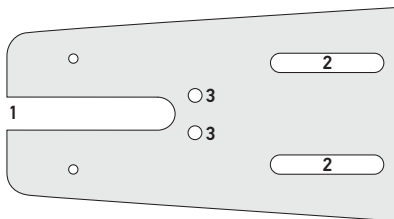

9136

Drive sprocket
tooth count:
9, 10

Dimensions:

- ① .516"

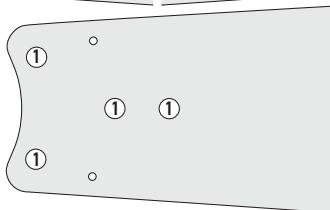

9164

Drive sprocket
tooth count:
9, 10

Dimensions:

- ① .531"

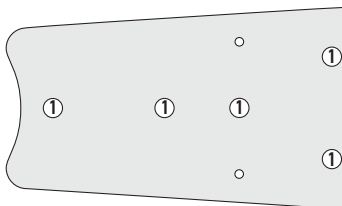
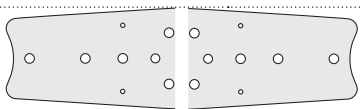

3/4" Pitch Guide Bar Mounts Asymmetrical Double-Ended

9155

Drive sprocket
tooth count: 15

Sprocket end
dimension:

① .656"

Idler end
dimension:

② .531"

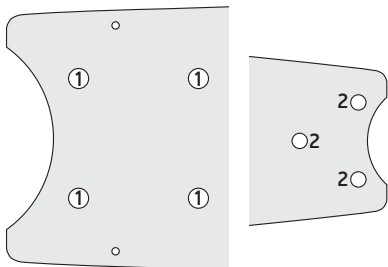

9191

Drive sprocket
tooth count: 14

Sprocket end
dimension:

① .760"

Idler end
dimension:

② .531"

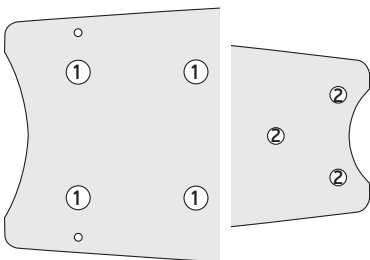

H175

Drive sprocket
tooth count: 21

① .656"

② .531"

Idler end
dimension:

③ .531"

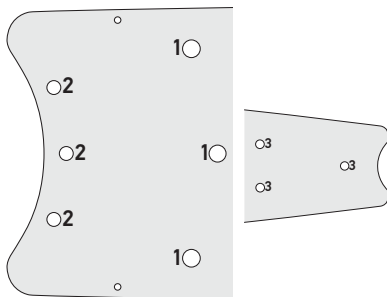

3/4" Pitch Guide Bar Mounts Asymmetrical Double-Ended

P155

Drive sprocket
tooth count: 15

Sprocket end
dimension:

① .656"

Idler end
dimension:

② .531"

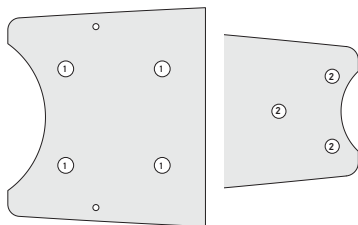

P207

Drive sprocket
tooth count: 15

Sprocket end
dimension:

① .781"

Idler end
dimension:

② .531"

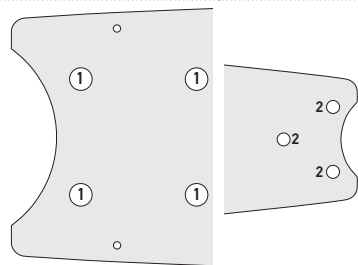

Guide Bar Maintenance

For proper mounting of your guide bar, refer to the operator's manual.

Basic Guide Bar Maintenance Tasks

▲ Before each use

● Daily

■ Often (hourly, or at refueling)

◆ Weekly, periodically

1. ▲ ■ Saw chain tensioning (See "Installation and Break-In" pg. 13)

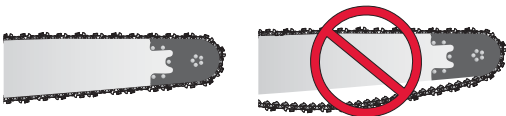

2. ● Inspect for damage and component wear; (refer to Guide Bar Troubleshooting, pgs. 83 – 90) replace as needed. Check bar groove depth after dressing by using the Oregon Harvester Multi-Purpose tool.

3. ◆ Clean guide bar grooves and oil holes.

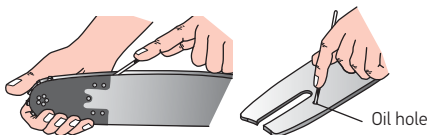

4. ◆ Turn your guide bar over to equalize bar wear.

5. ◆ Dress the rail—always dressing from the bar tip to the bar mount. Note: If using a grinding wheel, direct debris towards the tail, then clean out the grooves. Grinding debris can cause the nose components to wear quickly or jam.

Guide Bar Maintenance

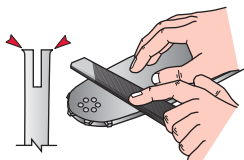

Bar Rail Dresser, p/n 111589 makes it easy to remove effects of normal wear and remove minor damage.

7. ♦ On sprocket-nose guide bars, check for clearance around the guide bar's tip, between the tops of rails, and the chassis. Replace nose sprockets before cutters or tie-straps contact the bar nose rails.

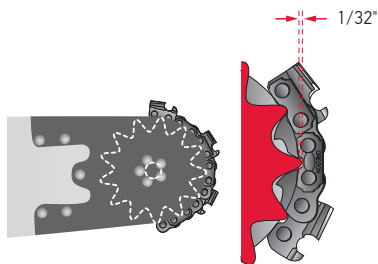

Sprocket Nose Replacement: HS

Replacing Nose Sprockets on HS Harvester Guide Bars

⚠ WARNING: Wear eye protection and gloves.

Select a new Harvester nose sprocket with the correct gauge for your guide bar and saw chain.



1. Using a 1/4" drill bit, drill out head from each of the nose sprocket rivets.

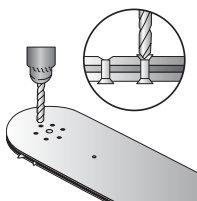

2. Punch out the remainder of the rivets. Use a punch narrow enough to keep from damaging the rivet holes in the nose of the guide bar.

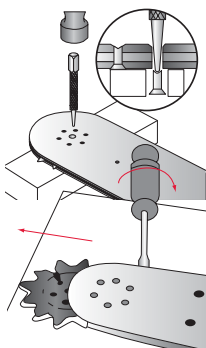

3. Use a small screwdriver to spread the guide bar nose rails just enough to remove the old nose sprocket. Clean debris from the sprocket area.

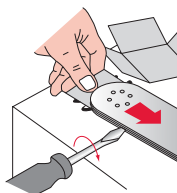

Sprocket Nose Replacement: HS

4. Inside the nose sprocket package, you'll find the new sprocket wrapped in a tissue. Be careful to keep the sprocket inside the tissue as you remove it from the package — bearings are easily lost. Slide the tissue and the new sprocket, together, into the guide bar's nose.

5. Once fully inside the nose, hold the nose sprocket in place, then remove the tissue.

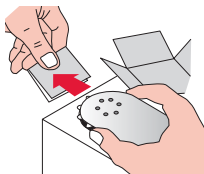

6. Align the sprocket's inner race holes with the holes in the guide bar nose. Insert rivets into each hole through the guide bar. On used guide bars, the nose rails could be spread apart. Use a small clamp to hold the nose rails together when inserting and securing the rivets.

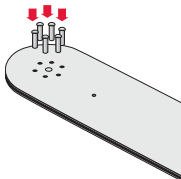

7. With the guide bar and rivets solidly supported on a strong, flat metal surface, carefully peen the rivet heads down with the flat end of a hammer. Be careful to hit only the rivet head. Do not hit the guide bar body — this will pinch the nose sprocket. Rivet heads must be snug and secure while still allowing the drive sprocket to turn freely.

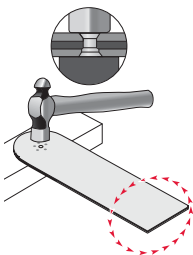

8. Clean out the bar groove to ensure it is free of possible debris.

Replacing Nose Sprockets with Replacement Nose Kits on RH, SM, and SN Guide Bars

1. Using the Oregon heavy-duty chain breaker #24548, break out the bar tip attachment rivets.

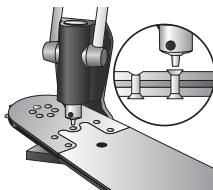

2. Using the heavy-duty chain breaker #24548, break out the remaining rivets. Use a punch narrow enough to keep from damaging the rivet holes in the nose of the guide bar.

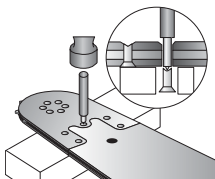

3. Remove the old nose. Clean the guide bar's attachment area. Insert the rivets through the underside of the nose.

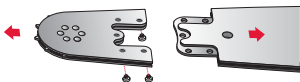

4. With the guide bar body, nose, and rivet solidly supported on a strong flat metal surface, peen the rivet's head down with the flat end of a hammer. Do not hit the guide bar body; hit only the rivet head. To check installation, grip the guide bar body in one hand and twist. The nose and body should feel like a single, solid piece. If you feel any movement in the nose guide bar joint area, or if you hear any clicking sounds from the same area, tighten the rivet with a few more hammer strokes.

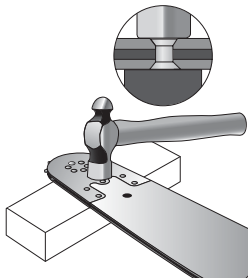

Sprocket Nose Replacement Nose: RH, SM, and SN Guide Bars

5. File down the rails of the new nose to align with the rails of the old guide bar body.
6. Clean out the bar groove to ensure it is free of possible debris.

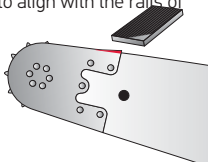

Guide Bar Troubleshooting

Rail Conditions



1. Rails are worn down, groove becomes shallow.

Cause: Normal wear on rails.

Symptoms: Chain rides on groove bottom causing drive link damage, chain leans during cutting.

Remedy: Guide bar is at the end of life, replace the guide bar. If wear occurs too quickly, check for proper lubrication, chain sharpness, and guide bar feed load.



2. Outside edge of rails develop wire edges.

Cause: Normal wear on rails.

Symptoms: Left alone, wire edges can break off and chip away rail material.

Remedy: Use flat file or grinder to square up the guide bar's rails and remove wire edges. If wire edges develop too quickly, check for proper lubrication, saw chain sharpness, and guide bar feed load.

Note: If using a grinding wheel, direct debris towards the tail, then clean out the grooves. Grinding debris can cause nose components to wear quickly or jam.



3. Rail on one side is worn thin.

Cause: Damaged or dull cutters on one side (see saw chain section). Saw chain leaning over in a worn groove or using a .063"-gauge saw chain in a .080"-gauge guide bar.

Symptoms: Incomplete cuts, leading cuts, guide bar bound in the cut.

Remedy: Replace the guide bar, check for the correct saw chain gauge, replace the saw chain if it continues to cut crooked after sharpening (see Sharpening Saw Chain, pgs. 35 – 38).

Guide Bar Troubleshooting

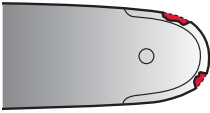

4. Rails around the tip of solid-nose guide bars show small cracks or broken-out sections.

Cause: Accidents or irregular operating techniques, which push drive links sideways or place excessive pressure on the nose, can cause breaks or cracks.

Symptoms: Damage to tie-straps and cutters, saw chain throws, short guide bar life.

Remedy: Your dealer may be able to repair minor damage on a relatively new guide bar. If not, replace guide bar immediately.

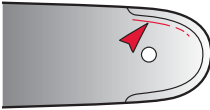

5. Rails around the tip of the solid-nose guide bars are split at the bottom of the guide bar groove.

Cause: Accidents or irregular operating techniques, which push drive links sideways or place excessive pressure on side of the nose, can cause breaks or cracks.

Symptoms: Rails spread and chain rides on the groove bottom, causing drive link damage and the saw chain leans during cutting.

Remedy: Your dealer may be able to repair minor damage on a relatively new guide bar. If not, replace guide bar immediately.



6. Rails along the guide bar body or around the tip of sprocket nose guide bars show blue discoloration.

Cause: Pinched rails, lack of lubrication, or accidents and improper cutting techniques. These actions can push drive links sideways in the groove, creating extreme friction-generated heat.

Symptoms: Blue spots on rails indicate temperatures reaching 600° F (315° C) and rail softening. Rails wear quickly. Saw chain drive link damage.

Remedy: Replace the guide bar and saw chain.

Guide Bar Troubleshooting



7. Blue spots at the tail of the guide bar.

Cause: Misaligned drive sprocket or rails pinched because debris not removed from saw pad or guide bar when the guide bar was installed.

Symptoms: Blue spots on rails indicate temperatures reaching 600° F (315° C) and softened rails. Rails wear quickly. Saw chain drive link damage.

Remedy: Realign drive sprocket and guide bar using proper shims. Clean the guide bar and saw pad when installing a guide bar. Replace the saw chain.



8. Spread rails.

Cause: (1) Saw chain was struck broadside by tree, log, or branch stub. (2) Saw chain was pushed sideways, forcing drive links to pry guide bar rails apart.

Symptoms: Guide bar will not enter log during cut or cannot make a complete cut.

Remedy: Hammer rails together with a drive link in the groove as spacer. Adjust the saw return to allow the guide bar to go farther into the saw box. Sharpen delimiting knives. Avoid moving the tree/log when the guide bar and saw chain are out of the saw box. Reduce the guide bar feed speed.



9. Rail chipping in the middle of guide bar.

Cause: Excessive pressure on the guide bar, excessive guide bar feed speed, cold conditions, lack of lubrication, aggressive saw chain when cutting in frozen wood.

Symptoms: Damage to the saw chain and reduced guide bar life.

Remedy: Replace the guide bar if rail wear is extensive. Decrease the guide bar feed force when cutting consists mostly of small-diameter trees. Increase lubrication, especially in cold conditions. Reduce aggressiveness of the saw chain when cutting frozen wood.

Guide Bar Troubleshooting



10. Rail on one side worn low.

Cause: Damaged or dull cutters on one side, or saw chain leaning over in a worn groove, or using .063" saw chain in .080" guide bar. Most often one short rail is caused by the cutters contacting rocks on one side of the saw chain, usually the cutters closest to the ground.

Symptoms: Incomplete cuts, leading cuts, guide bar bound in the cut.

Remedy: Replace the guide bar. Replace the saw chain. If the saw continues to cut crookedly after sharpening, see Sharpening Saw Chain (pgs. 31 – 38).

Guide Bar Troubleshooting

Nose Conditions

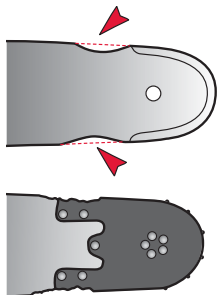

11. Chipped rails or excessive rail wear a few inches back from the nose end of the bar.

Cause: Loose saw chain tension.

Symptoms: Saw chain damage, saw chain throwing, shortened guide bar life.

Remedy: Use proper saw chain tension and invert the guide bar on the saw periodically to distribute wear.



12. Rails in the tip of a sprocket-nose guide bar spread, allowing loss of bearings.

Cause: Accidents or irregular operating techniques twist the nose or push the drive links sideways against the nose's rails.

Symptoms: Sprocket breakage.

Remedy: Replace sprocket components. Keep the guide bar nose away from objects not intended for cutting.

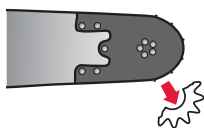

13. Sprocket in the sprocket nose guide bar breaks.

Cause: High saw chain tension, accidents, saw chain broadsided by log, pulling saw chain out of the guide bar rails.

Symptoms: Guide bar nose sprocket no longer functions.

Remedy: Replace sprocket components. Use proper saw chain tension.

Guide Bar Troubleshooting

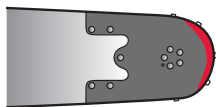

14. Nose burned at tip from the saw chain sliding on rails of the sprocket nose guide bar, or from the sprocket being recessed into the tip.

Cause: High saw chain tension from automatic saw chain tensioners.

Symptoms: Nose breakage from bearings wearing quickly and jamming.

Remedy: Decrease the tension applied by the automatic saw chain tensioner.

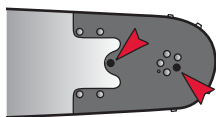

15. Loose or missing nose/attachment rivets.

Cause: The guide bar tip flexing during operation from difficult cutting conditions or accidents.

Symptoms: Rivets continue to loosen until laminates spread and the bearings are lost.

Remedy: Check rivets every 100 machine hours. Rehammer loose rivets and replace rivets if the rivet head is missing. Always use new rivets.

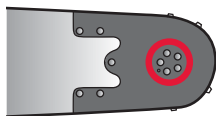

16. Burn ring around nose rivets.

Cause: Bearings overheated.

Symptoms: Premature breakage, jamming, wearing of the sprocket nose components.

Remedy: Check for proper oil flow rates. Saw chips will plug oil line or guide bar oil hole. Clean out the bar oil hole daily. Install a wire mesh screen on the oil tank filler spout to prevent chips from getting into the tank.

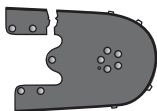

17. Tabs on the replaceable nose sprocket (RSN) break off.

Cause: Accidental bending of the nose.

Symptoms: RSN no longer functions.

Remedy: Install new RSN. Avoid bending the RSN.

Guide Bar Troubleshooting

Mount Conditions

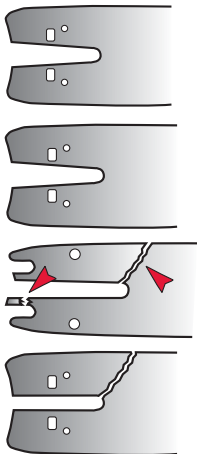

18. Spread or broken guide bar mounting slot.

Cause: Holding pins/bolts were not inserted into the guide bar mount holes. The guide bar is not properly supported when minor accidents or pinches occur.

Symptoms: The guide bar mount slot spreads or the guide bar breaks at the slot prematurely. If a Jet-Fit® guide bar fails from the tip of the middle slot to the side as shown without the small tab also breaking, then pins are missing or broken off.

Remedy: Replace broken guide bars and use the holding pins/bolts originally supplied with the guide bar holder. When purchasing a new harvester head, consider purchasing head compatible with Jet-Fit guide bars.

Jet-Fit Mount Conditions

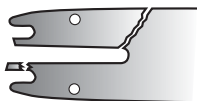

19. Chronic or frequent guide bar mount breakage on Jet-Fit guide bars when no accident has occurred.

Cause: The guide bar retraction speed is too fast. The forward guide bar-sweep speed is too fast, causing the guide bar holder to stop quickly at the end of its rotation.

In either case, the inertia of the guide bar causes it to over-rotate in the guide bar mount, putting excessive stress on the guide bar mount.

Symptoms: Guide bar breakage without the guide bar being involved in an accident. Unexplained guide bar mount breakage.

Remedy: Reduce pressure, or flow, to the cylinder that sweeps the guide bar forward, out of the saw box, or retracts the guide back into the saw box.

Guide Bar Troubleshooting

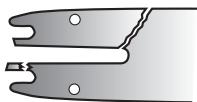

20. Occasional failure of Jet-Fit guide bars when accidents occur.

Cause: The guide bar becomes stuck in the cut, or an accident occurs causing the guide bar to become stuck.

Symptoms: The force required to dislodge the guide bar approaches the strength of the guide bar holder, during which the guide bar mount breaks.

Remedy: In this case, the Jet-Fit guide bar breaks as designed to prevent damage to the expensive guide bar mount as shown in the illustration below.



Drive Sprockets



Drive Sprocket Types

Drive sprockets transfer power from your machine to your saw chain to drive it around your guide bar. Drive sprockets are the third member of your saw chain-based cutting system. They will wear as a team and should be inspected and maintained as a team.

Type	Advantages	Disadvantages
Rim 	<ul style="list-style-type: none">• Best saw chain support for cutters and tie-straps.	<ul style="list-style-type: none">• Setup is important: the rim must be properly aligned with guide bar*

*Check the alignment of your rim drive sprocket regularly and use shims to adjust the rim's position into correct alignment. See pages 95 for more information on drive sprocket alignment.

HarvesterLok®
Rim



- Uniform pressure eliminates distortion, warping.
- Fittings for smaller shafts.
- Keyless hub.
- Hex-head set screws for quick installation, adjustment, and removal in the field.
- No space between the drive sprocket and shaft gives zero backlash.
- Drive sprocket must be aligned to the drive shaft to prevent damage to the saw chain, guide bar and drive sprocket.

.404" Drive-Shaft Configurations

Oregon .404" pitch rim sprockets are configured for use with Oregon saw chain. Sprockets are compatible with A, B, and C drive-shaft configurations.

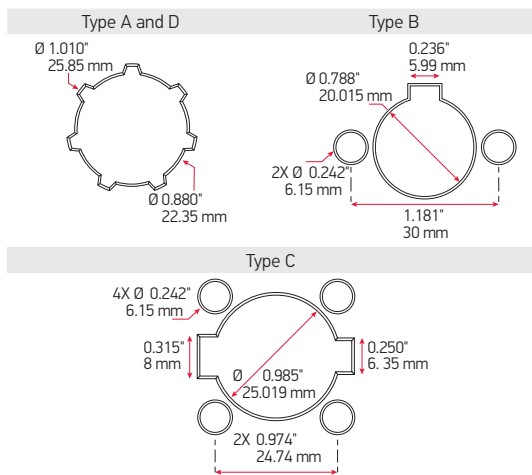

Drive Sprocket Alignment



596397 .404" Pitch
Harvester Multi-Purpose Tool



533700 3/4" Pitch
Harvester Multi-Purpose Tool

1. Mount your harvester guide bar on your harvester head.
2. Using the tool that matches your saw chain pitch, place the Harvester Multi-Purpose tool into the groove of your guide bar and slide it back until it extends to the drive sprocket.
3. Adjust the drive sprocket's position on the drive shaft until it's centered on the Harvester Multi-Purpose Tool.
4. Install shims as necessary to ensure alignment.
5. Secure the drive sprocket in place.

OR-B050 • 0.5 mm



OR-B100 • 1.0 mm



OR-C050 • 0.5 mm



OR-C100 • 1.0 mm



Drive Sprocket Alignment

3/4"-Pitch Drive Sprockets



Rims



HarvesterLok®

- Our 3/4"-pitch drive sprockets are available in two types: Rims and HarvesterLok®.
- Unlike rim drive sprockets on chainsaws that float and self-align, harvester rim drive sprockets are fixed.
- Improper drive sprocket alignment can result in a thrown loop of saw chain. It may be necessary to use shims to ensure proper alignment of the drive sprocket groove with the guide bar's groove.
- Alignment can be checked using an Oregon Harvester Multi-Purpose tool.

Drive Sprockets Troubleshooting

When to Replace Your Drive Sprocket

Regardless of pitch or design, harvester drive sprockets should be replaced when damage is observed.

.404"-Pitch Drive Sprockets

Rims should be replaced when the depth of the wear on the surface of the rim reaches 0.025" (0.635 mm).

3/4"-Pitch Drive Sprockets

Rims and the HarvesterLok rims should be replaced when the depth of the wear on the surface of the rim reaches 0.025" (0.635 mm).

The Drive Sprocket is the third component of your cutting system; regular inspection and maintenance is critical. Damaged, misused, or worn harvester drive sprockets will damage and shorten the life of operation of your entire system. Damaged, misused, or worn harvester drive sprockets cannot be repaired; they can only be replaced.

NOTE: A new saw chain can be ruined if installed on a worn rim or spur drive sprocket.

Check the wear on your rim or spur drive sprocket daily, and before each session of use. If worn, replace the drive sprocket before installing a new saw chain. Here are the things you should look for, and the corrective actions you should take:

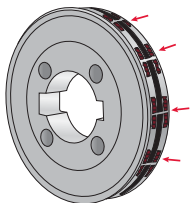

Worn rim drive sprocket

Cause: Used beyond service life causing excessive wear on outer and inner surfaces of rim drive sprocket.

Symptoms: Saw chain breakage. Drive link wear, breakage.

Remedy: Replace rim drive sprocket

Hydraulic Pump Information

Definitions

Hp = Horsepower	eff. = Efficiency
RPM = Revolutions per minute	psi = Pounds per square inch
d = Displacement, cubic inches	GPM = Displacement, cubic inches
T = Torque	

Pump Calculations

Hp = $\frac{\text{GPM} \times \text{psi}}{1714 \times \text{eff. (pump)}}$	or Hp = $\frac{.000583 \times \text{GPM} \times \text{psi}}{\text{eff. (pump)}}$
Hp = $\frac{\text{T} \times \text{RPM}}{5252}$ Torque (lb.-ft.)	or Hp = $\frac{\text{T} \times \text{RPM}}{63025}$ Torque (lb.-ft.)
Hp = $\frac{\text{volts} \times \text{amperes}}{745.7}$	

Pump Output Flow

GPM = $\frac{\text{RPM} \times \text{d}}{231 \text{ cu. in.}}$	1 gal. = 231 cu. in.
---	-----------------------------

Notes

This Timber Harvesting Handbook supersedes and replaces all previous Oregon Timber Harvesting Handbooks.

Oregon[®], HarvesterLok[®], Jet-Fit[®], Chamfer Chisel[™], SpeedMax[™], Micro Chisel[®], and LubriTec[™] are trademarks of Blount, Inc.

Blount, Inc. • ©2017

OregonProducts.com

(800) 223-5168

OregonProductSupport@Blount.com