

WALLENSTEIN

BY EMB MFG INC.

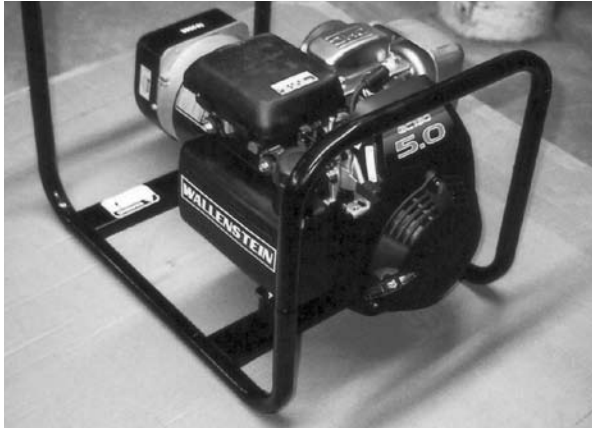

EC2500



EC2600



EC3300



EC5000

PORTABLE GENERATOR MODELS EC2500, EC2600, EC3300 & EC5000

OPERATOR'S MANUAL

WALLENSTEIN PORTABLE GENERATOR

WARRANTY

This product is warranted to be free of defects in materials and workmanship under normal use and service, for a period of two years from the date of purchase, when operated and maintained in accordance with the Operating and Maintenance Instructions supplied with this unit. This warranty does not cover misuse or negligence.

Under no circumstances will the manufacturer be liable for any consequential damage or expense of any kind, including loss of profits. The manufacturer is under no circumstances liable for tractor damage of any kind. The manufacturer is not liable for the maintenance of the product.

This warranty is extended only to the original purchaser. Warranty is void if repairs are attempted by anyone other than an Authorized Service Centre.

If a difficulty develops with the product, you should contact your nearest Authorized Repair Centre, or distributor. Only these locations are authorized to make repairs to the product or affect the replacement of defective parts, which will be done at no charge within a reasonable time after the receipt of the product. Unit or parts should be returned at the customer's expense to the nearest repair location or Authorized Service Centre. Damage in-transit is not covered by warranty. Include original purchase receipt with any claim (keeping a copy for your files).

The distributor's liability under warranty is limited to repair of the product and/or replacement of parts and is given to the purchaser in lieu of all other remedies including incidental and consequential charges. There are no warranties, expressed or implied other than those specified herein. For the nearest Authorized Service Centre call the manufacturer. For Honda engine service contact your local Honda dealer or www.honda.ca.

EMB Manufacturing Inc.
4144 Boomer Line
St. Clements, ON
N0B 2M0 Canada
Phone: 519-699-9283
Fax: 519-699-4146

WARRANTY VOID IF NOT REGISTERED

**WALLENSTEIN
PORTABLE GENERATOR**

WARRANTY REGISTRATION FORM & INSPECTION REPORT

WARRANTY REGISTRATION (please print)

This form must be filled out by the dealer and signed by both the dealer and the customer at the time of delivery.

Customer's Name _____ Dealer Name _____
Address _____ Address _____
City, State/Province, Code _____ City, State/Province, Code _____
Phone Number (____) _____ Phone Number (____) _____
Contact Name _____
Model _____
Serial Number _____
Delivery Date _____

DEALER INSPECTION REPORT

____ Fasteners Tight
____ Check Electrical Connections
____ Check Engine Fluid Levels

SAFETY

____ All Decals Installed
____ Guards and Shields Installed and Secured
____ Review Operating and Safety Instructions

I have thoroughly instructed the buyer on the above described equipment which review included the Operator's Manual content, equipment care, adjustments, safe operation and applicable warranty policy.

Date _____ Dealer's Rep. Signature _____

The above equipment and Operator's Manual have been received by me and I have been thoroughly instructed as to care, adjustments, safe operation and applicable warranty policy.

Date _____ Owner's Signature _____

WHITE	YELLOW	PINK
EMB MFG., INC	DEALER	CUSTOMER

SERIAL NUMBER LOCATION

Always give your dealer the serial number of your Wallenstein Portable Generator when ordering parts or requesting service or other information.

The serial number plates are located where indicated. Please mark the numbers in the spaces provided for easy reference.

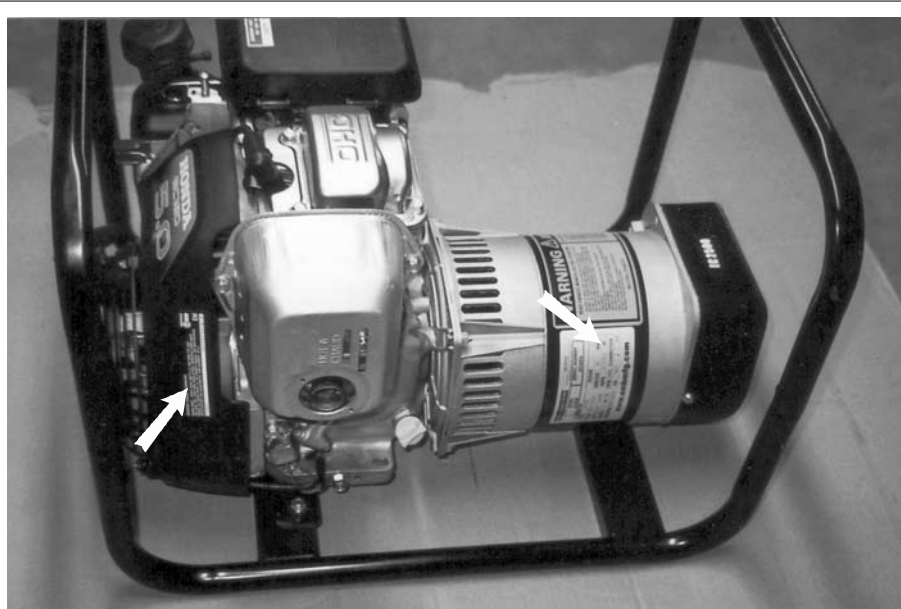

EC2500

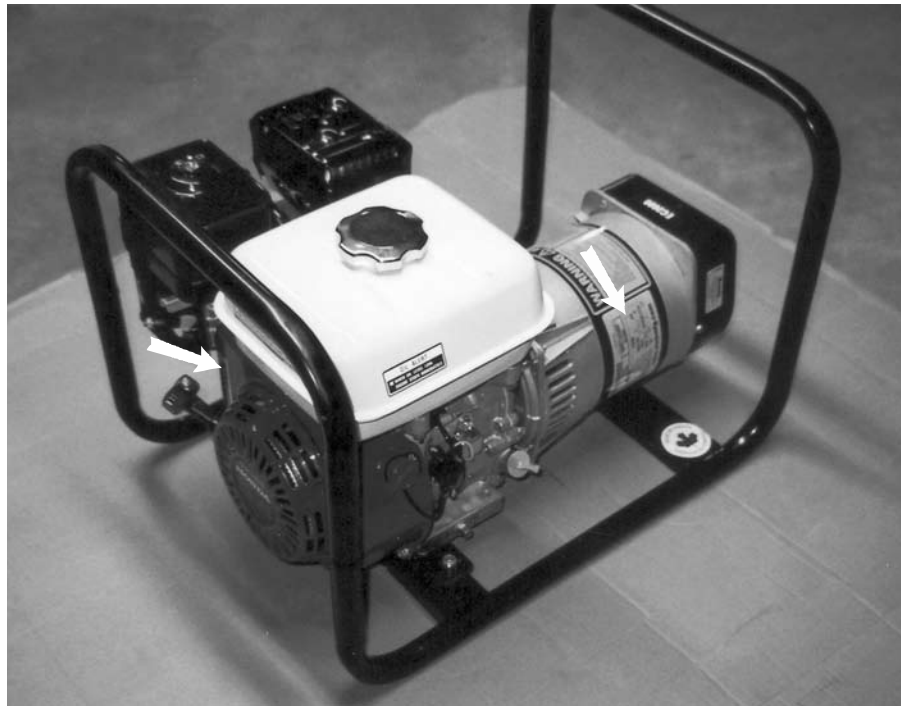

EC2600

SERIAL NUMBER LOCATION

Model Number _____

Generator Serial Number _____

Engine Serial Number _____

TABLE OF CONTENTS

SECTION	DESCRIPTION	PAGE
1	Introduction	1
2	Safety.....	2
2.1	General Safety	3
2.2	Equipment Safety Guidelines	4
2.3	Safety Training	5
2.4	Safety Signs.....	5
2.5	Preparation	6
2.6	Maintenance Safety	6
2.7	Operation Safety	7
2.8	Refueling Safety	7
2.9	Storage Safety	7
2.10	Gas Motor Safety	8
2.11	Employee Sign-Off Form	9
3	Safety Sign Locations	10
4	Assembling	12
5	Operation	13
5.1	To the New Operator or Owner.....	13
5.2	Machine Components.....	14
5.3	Machine Break-In.....	15
5.4	Pre-Operation Checklist.....	15
5.5	Controls	16
5.6	Field Operation	18
5.7	Moving	23
5.8	Storage	24
6	Service and Maintenance	25
6.1	Service.....	25
6.2	Maintenance	30
7	Troubleshooting	32
8	Specifications.....	33
8.1	Mechanical.....	33
8.2	Bolt Torque.....	34
9	Index	35

1 INTRODUCTION

Congratulations on your choice of an Wallenstein Portable Generator to compliment your operation. This equipment has been designed and manufactured to meet the needs of a discerning person, operator or industry that needs portable electrical power.

Safe, efficient and trouble free operation of your Wallenstein Portable Generator requires that you and anyone else who will be using or maintaining the generator, read and understand the Safety, Operation, Maintenance and Trouble Shooting information contained within the Operator's Manual.

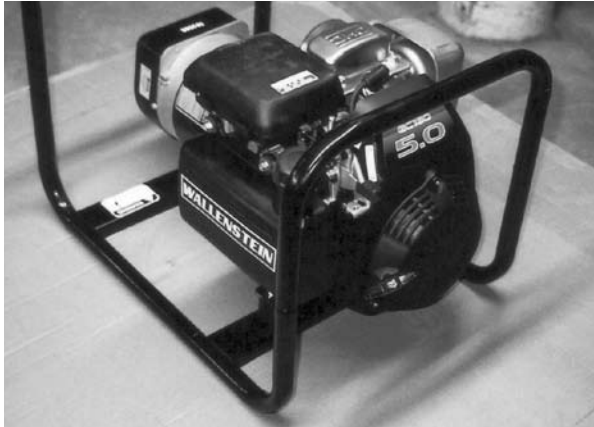

EC2500



EC2600



EC3300



EC5000

This manual covers the Wallenstein Portable Generator Models EC2500, EC2600, EC3300 and EC5000. Use the Table of Contents or Index as a guide to locate required information.

Keep this manual handy for frequent reference and to pass on to new operators or owners. Call your Wallenstein dealer or the Distributer if you need assistance, information or additional copies of the manuals.

OPERATOR ORIENTATION - The directions left, right, front and rear, as mentioned throughout this manual, are determined when standing and looking at the electrical panel.

2 SAFETY

SAFETY ALERT SYMBOL

This Safety Alert symbol means
ATTENTION! BECOME ALERT!
YOUR SAFETY IS INVOLVED!



The Safety Alert symbol identifies important safety messages on the Wallenstein Portable Generator and in the manual. When you see this symbol, be alert to the possibility of personal injury or death. Follow the instructions in the safety message.

Why is SAFETY important to you?

3 Big Reasons

Accidents Disable and Kill
Accidents Cost
Accidents Can Be Avoided

SIGNAL WORDS:

Note the use of the signal words **DANGER**, **WARNING** and **CAUTION** with the safety messages. The appropriate signal word for each message has been selected using the following guide-lines:

DANGER - Indicates an imminently hazardous situation that, if not avoided, will result in death or serious injury. This signal word is to be limited to the most extreme situations typically for machine components which, for functional purposes, cannot be guarded.

WARNING - Indicates a potentially hazardous situation that, if not avoided, could result in death or serious injury, and includes hazards that are exposed when guards are removed. It may also be used to alert against unsafe practices.

CAUTION - Indicates a potentially hazardous situation that, if not avoided, may result in minor or moderate injury. It may also be used to alert against unsafe practices.

If you have any questions not answered in this manual or require additional copies or the manual is damaged, please contact your dealer or Wallenstein, 4144 Boomer Line, St. Clements, ON, N0B 2M0. Phone (519) 669-9283 or Fax (519) 699-4146.

SAFETY

YOU are responsible for the SAFE operation and maintenance of your Wallenstein Portable Generator. **YOU** must ensure that you and anyone else who is going to use, maintain or work around the Portable Generator be familiar with the using and maintenance procedures and related **SAFETY** information contained in this manual. This manual will take you step-by-step through your working day and alerts you to all good safety practices that should be used while using the Portable Generator.

Remember, **YOU** are the key to safety. Good safety practices not only protect you but also the people around you. Make these practices a working part of your safety program. Be certain that **EVERYONE** using this equipment is familiar with the recommended using and maintenance procedures and follows all the safety precautions. Most accidents can be prevented. Do not risk injury or death by ignoring good safety practices.

- Portable Generator owners must give operating instructions to operators or employees before allowing them to operate the machine, and at least annually thereafter.
- The most important safety device on this equipment is a SAFE operator. It is the operator's responsibility to read and understand ALL Safety and Operating instructions in the manual and to follow these. Most accidents can be avoided.
- A person who has not read and understood all using and safety instructions is not qualified to use the machine. An untrained operator exposes himself and bystanders to possible serious injury or death.
- Do not modify the equipment in any way. Unauthorized modification may impair the function and/or safety and could affect the life of the equipment.
- Think SAFETY! Work SAFELY!

2.1 GENERAL SAFETY

1. Read and understand the Operator's Manual and all safety signs before using, maintaining, adjusting or cleaning the Portable Generator.

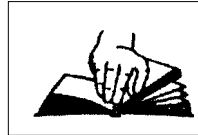

2. Have a first-aid kit available for use should the need arise and know how to use it.



3. Have a fire extinguisher available for use should the need arise and know how to use it.

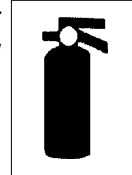

4. Wear appropriate protective gear. This list includes but is not limited to:

- A hard hat
- Protective shoes with slip resistant rubber soles
- Protective glasses, goggles or face shield
- Heavy gloves
- Hearing Protection



5. Install and secure all guards before starting.

6. Wear suitable ear protection for prolonged exposure to excessive noise.

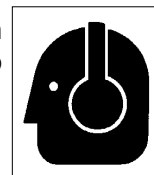

7. Stop and disable engine, remove ignition key and place in your pocket and wait for all moving parts to stop before servicing, adjusting or repairing.

8. Clear the area of people, especially small children, before using the unit.

9. Review safety related items annually with all personnel who will operating or maintaining the Portable Generator.

2.2 EQUIPMENT SAFETY GUIDELINES

1. Safety of the operator and bystanders is one of the main concerns in designing and developing equipment. However, every year many accidents occur which could have been avoided by a few seconds of thought and a more careful approach to handling equipment. You, the operator, can avoid many accidents by observing the following precautions in this section. To avoid personal injury or death, study the following precautions and insist those working with you, or for you, follow them.
2. In order to provide a better view, certain photographs or illustrations in this manual may show an assembly with a safety shield removed. However, equipment should never be used in this condition. Keep all shields in place. If shield removal becomes necessary for repairs, replace the shield prior to use.
3. Replace any safety sign or instruction sign that is not readable or is missing. Location of such safety signs is indicated in this manual.
4. Never use alcoholic beverages or drugs which can hinder alertness or coordination while using this equipment. Consult your doctor about using this machine while taking prescription medications.
5. **Under no circumstances should young children be allowed to work with this equipment. Do not allow persons to use or assemble this unit until they have read this manual and have developed a thorough understanding of the safety precautions and of how it works.** Review the safety instructions with all users annually.
6. This equipment is dangerous to children and persons unfamiliar with its operation. The operator should be a responsible, properly trained and physically able person familiar with machinery and trained in this equipment's operations. If the elderly are assisting with work, their physical limitations need to be recognized and accommodated.
7. Never exceed the limits of a piece of machinery. If its ability to do a job, or to do so safely, is in question - **DON'T TRY IT.**
8. Do not modify the equipment in any way. Unauthorized modification may result in serious injury or death and may impair the function and life of the equipment.
9. In addition to the design and configuration of this implement, including Safety Signs and Safety Equipment, hazard control and accident prevention are dependent upon the awareness, concern, prudence, and proper training of personnel involved in the operation, transport, maintenance, and storage of the machine. Refer also to Safety Messages and operation instruction in each of the appropriate sections of the engine and machine manuals. Pay close attention to the Safety Signs affixed to the engine and the machine.

2.3 SAFETY TRAINING

1. Safety is a primary concern in the design and manufacture of our products. Unfortunately, our efforts to provide safe equipment can be wiped out by a single careless act of an operator or bystander.
2. In addition to the design and configuration of equipment, hazard control and accident prevention are dependent upon the awareness, concern, prudence and proper training of personnel involved in the operation, transport, maintenance and storage of this equipment.
3. It has been said, "The best safety feature is an informed, careful operator." We ask you to be that kind of an operator. It is the operator's responsibility to read and understand ALL Safety and Using Instructions in the manual and to follow these. Accidents can be avoided.
4. **Working with unfamiliar equipment can lead to careless injuries. Read this manual before assembly or using, to acquaint yourself with the machine. If this machine is used by any person other than yourself, or is loaned or rented, it is the machine owner's responsibility to make certain that the operator, prior to using:**
 - a. **Reads and understands the operator's manuals.**
 - b. **Is instructed in safe and proper use.**
5. Know your controls and how to stop engine and machine quickly in an emergency. Read this manual and the one provided with your engine.
6. Train all new personnel and review instructions frequently with existing workers. Be certain only a properly trained and physically able person will use the machinery. A person who has not read and understood all using and safety instructions is not qualified to use the machine. An untrained operator exposes himself and bystanders to possible serious injury or death. If the elderly are assisting with the work, their physical limitations need to be recognized and accommodated.

2.4 SAFETY SIGNS

1. Keep safety signs clean and legible at all times.
2. Replace safety signs that are missing or have become illegible.
3. Replaced parts that displayed a safety sign should also display the current sign.
4. Safety signs displayed in Section 3 each have a part number in the lower right hand corner. Use this part number when ordering replacement parts.
5. Safety signs are available from your authorized Distributor or Dealer Parts Department or the factory.

How to Install Safety Signs:

- Be sure that the installation area is clean and dry.
- Be sure temperature is above 50°F (10°C).
- Determine exact position before you remove the backing paper.
- Remove the smallest portion of the split backing paper.
- Align the sign over the specified area and carefully press the small portion with the exposed sticky backing in place.
- Slowly peel back the remaining paper and carefully smooth the remaining portion of the sign in place.
- Small air pockets can be pierced with a pin and smoothed out using the piece of sign backing paper.

2.5 PREPARATION

1. Never use the engine and machine until you have read and completely understand this manual, the Engine Operator's Manual and each of the Safety Messages found on the safety signs on the engine and machine.

2. Personal protection equipment including hard hat, safety glasses, safety shoes, and gloves are recommended during assembly, installation, operation, adjustment, maintaining, repairing, removal, cleaning, or moving the unit. Do not allow long hair, loose fitting clothing or jewellery to be around equipment.

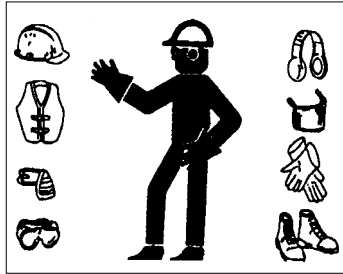

3. **PROLONGED EXPOSURE TO LOUD NOISE MAY CAUSE PERMANENT HEARING LOSS!**

Power equipment with or without equipment attached can often be noisy enough to cause permanent, partial hearing loss. We recommend that you wear hearing protection on a full-time basis if the noise in the Operator's position exceeds 80db. Noise over 85db on a long-term basis can cause severe hearing loss. Noise over 90db adjacent to the Operator over a long-term basis may cause permanent, total hearing loss. **NOTE:** Hearing loss from loud noise (from tractors, chain saws, radios, and other such sources close to the ear) is cumulative over a lifetime without hope of natural recovery.

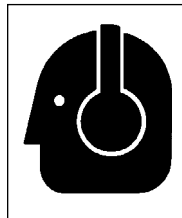

4. Clear working area of stones, branches or hidden obstacles that might be hooked or snagged, causing injury or damage.
5. Use only in daylight or good artificial light.
6. Be sure machine is properly positioned, adjusted and in good operating condition.
7. Ensure that all safety shielding and safety signs are properly installed and in good condition.

2.6 MAINTENANCE SAFETY

1. Good maintenance is your responsibility. Poor maintenance is an invitation to trouble.
2. Follow good shop practices.

- Keep service area clean and dry.
- Be sure electrical outlets and tools are properly grounded.
- Use adequate light for the job at hand.



3. Make sure there is plenty of ventilation. Never operate the engine of the towing vehicle in a closed building. The exhaust fumes may cause asphyxiation.
4. Before working on this machine, shut off the engine and turn fuel valve off.
5. Never work under equipment unless it is blocked securely.
6. Always use personal protection devices such as eye, hand and hearing protectors, when performing any service or maintenance work.
7. Where replacement parts are necessary for periodic maintenance and servicing, genuine factory replacement parts must be used to restore your equipment to original specifications. The manufacturer will not be responsible for injuries or damages caused by use of unapproved parts and/or accessories.
8. A fire extinguisher and first aid kit should be kept readily accessible while performing maintenance on this equipment.
9. Periodically tighten all bolts, nuts and screws and check that all electrical and fuel connections are properly secured to ensure unit is in a safe condition.
10. When completing a maintenance or service function, make sure all safety shields and devices are installed before placing unit in service.

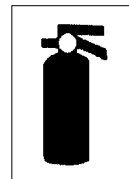
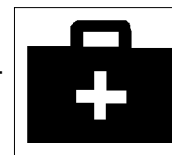

2.7 OPERATING SAFETY

1. Read and understand operator's manual before starting. Review safety instructions annually.
2. Stop and disable engine, remove ignition key and place in your pocket and wait for all moving parts to stop before servicing, adjusting or repairing.
3. To prevent electrical shocks, do not operate this generator in the rain or with wet hands. It should be grounded in damp or highly conductive conditions.
4. Close and secure all guards, deflectors and shields before starting and operating.
5. Do not connect the generator to a commercial power line.
8. Do not operate with damaged or defective extension cords, or power cords. Never operate any electrical equipment with damaged or defective cords.
9. Do not operate this generator in areas with poor ventilation. The exhaust fumes contain carbon monoxide, a poisonous, odorless, invisible gas. Prolonged exposure can lead to unconsciousness and death.
10. Do not refuel the engine while it is in operation or still hot. Do not refuel the engine near open flames, pilot lights or sparking electrical devices (e.g. power tools, welders or grinders). Do not operate the generator near flammable products.
11. The engine should be refueled in a well-lit area. Avoid fuel spillage.
12. Never allow children or unauthorized people to operate or be around this machine.
13. Keep the working area clean and free of debris to prevent tripping. Operate only on level ground.
14. Do not cover the generator while in operation. Overheating can result in damaged equipment.
15. For storage, do not cover the generator until it has cooled down completely.
16. The ambient temperature should not exceed 100° F/40° C.

2.8 REFUELING SAFETY

1. Handle fuel with care. It is highly flammable.
2. Allow engine to cool for 5 minutes before refuelling. Clean up spilled fuel before restarting engine.
3. Do not refuel the machine while smoking or when near open flame or sparks.
4. Fill fuel tank outdoors.
5. Prevent fires by keeping machine clean of accumulated trash, grease and debris.



2.9 STORAGE SAFETY

1. Store the unit in an area away from human activity.
2. Do not allow children to play on or around the stored machine.
3. Store the unit in a dry, level area. Support the frame with planks if required.

2.10 GAS MOTOR SAFETY

BEFORE STARTING ENGINE, READ AND UNDERSTAND THE OPERATING AND MAINTENANCE INSTRUCTIONS THAT CAME WITH YOUR ENGINE.

WARNING: DO NOT

1. DO NOT run engine in an enclosed area. Exhaust gases contain carbon monoxide, an odourless and deadly poison.
2. DO NOT place hands or feet near moving or rotating parts.
3. DO NOT store, spill, or use gasoline near an open flame, or devices such as a stove, furnace, or water heater which use a pilot light or devices which can create a spark.
4. DO NOT refuel indoors where area is not well ventilated. Outdoor refuelling is preferred.
5. DO NOT refuel while engine is running. Allow engine to cool for 5 minutes before refuelling. Store fuel in approved safety containers.
6. DO NOT remove fuel tank cap while engine is running.
7. DO NOT operate engine if gasoline is spilled. Move machine away from the spill and avoid creating any ignition until gasoline has evaporated.
8. DO NOT smoke while filling fuel tank.
9. DO NOT choke carburetor to stop engine. Whenever possible, gradually reduce engine speed before stopping.
10. DO NOT run engine above rated speeds. This may result in injury.
11. DO NOT tamper with governor springs, governor links or other parts which may increase the governed speed.
12. DO NOT tamper with the engine speed selected by the original equipment manufacturer.
13. DO NOT check for spark with spark plug or spark plug wire removed.
14. DO NOT crank engine with spark plug removed. If engine is flooded, crank until engine starts.
15. DO NOT strike flywheel with a hard object or metal tool as this may cause flywheel to shatter in operation. Use proper tools to service engine.
16. DO NOT operate engine without a muffler. Inspect periodically and replace, if necessary. If engine is equipped with a muffler deflector, inspect periodically and replace, if necessary with correct deflector.
17. DO NOT operate engine with an accumulation of grass, leaves, dirt or other combustible materials in the muffler area.
18. DO NOT use this engine on any forest covered, brush covered, or grass covered unimproved land unless a spark arrester is installed on the muffler. The arrester must be maintained in effective working order by the operator. In the state of California the above is required by law (Section 4442 of the California Public Resources Code). Other states may have similar laws. Federal laws apply on federal land.
19. DO NOT touch hot muffler, cylinder or fins because contact may cause burns.
20. DO NOT run engine with air cleaner or air cleaner cover removed.

WARNING: DO

1. ALWAYS DO remove the wire from the spark plug when servicing the engine or equipment to prevent accidental starting. Disconnect the negative wire from the battery terminal if equipped with a 12 volt starting system.
2. DO keep cylinder fins and governor parts free of grass and other debris which can affect engine speed.
3. DO examine muffler periodically to be sure it is functioning effectively. A worn or leaking muffler should be repaired or replaced as necessary.
4. DO use fresh gasoline. Stale fuel can gum carburetor and cause leakage.
5. DO check fuel lines and fittings frequently for cracks or leaks. Replace if necessary.

3 SAFETY SIGN LOCATIONS

The types of safety signs and locations on the equipment are shown in the illustrations that follow. Good safety requires that you familiarize yourself with the various safety signs, the type of warning and the area, or particular function related to that area, that requires your SAFETY AWARENESS.

- Think SAFETY! Work SAFELY!

A

!**CAUTION**

- Read and understand operator's manual before starting. Review safety instructions annually.
- Stop and disable engine, remove ignition key and place in your pocket and wait for all moving parts to stop before servicing, adjusting or repairing.
- To prevent electrical shocks, do not operate this generator in the rain or with wet hands. It should be grounded in damp or highly conductive conditions.
- Close and secure all guards, deflectors and shields before starting and operating.
- Do not connect the generator to a commercial power line.
- Do not operate with damaged or defective extension cords, or power cords. Never operate any electrical equipment with damaged or defective cords.
- Do not operate this generator in areas with poor ventilation. The exhaust fumes contain carbon monoxide, a poisonous, odorless, invisible gas. Prolonged exposure can lead to unconsciousness and death.
- Do not refuel the engine while it is in operation or still hot. Do not refuel the engine near open flames, pilot lights or sparking electrical devices (e.g. power tools, welders or grinders). Do not operate the generator near flammable products.
- The engine should be refuelled in a well-lit area. Avoid fuel spillage.
- Never allow children or unauthorized people to operate or be around this machine.
- Keep the working area clean and free of debris to prevent tripping. Operate only on level ground.
- Do not cover the generator while in operation. Overheating can result in damaged equipment.
- For storage, do not cover the generator until it has cooled down completely.
- The ambient temperature should not exceed 100° F/40° C.

Z94074

B

!**DANGER**

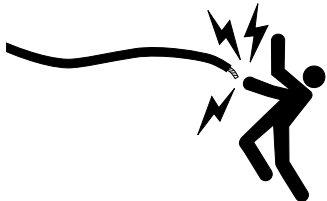

ELECTROCUTION HAZARD:

To prevent injury or death from electrocution:

- Do not operate with damaged or defective extension cords or power cords. Never operate any electrical equipment with damaged or defective cords.
- Do not operate the generator in the rain or with wet hands. It should be grounded in damp or highly conductive conditions.

Z94073

REMEMBER - If safety signs have been damaged, removed, become illegible or parts replaced without safety signs, new signs must be applied. New safety signs are available from your authorized dealer.

The types of safety signs and locations on the equipment are shown in the illustrations that follow. Good safety requires that you familiarize yourself with the various safety signs, the type of warning and the area, or particular function related to that area, that requires your SAFETY AWARENESS.

- Think SAFETY! Work SAFELY!



EC2500

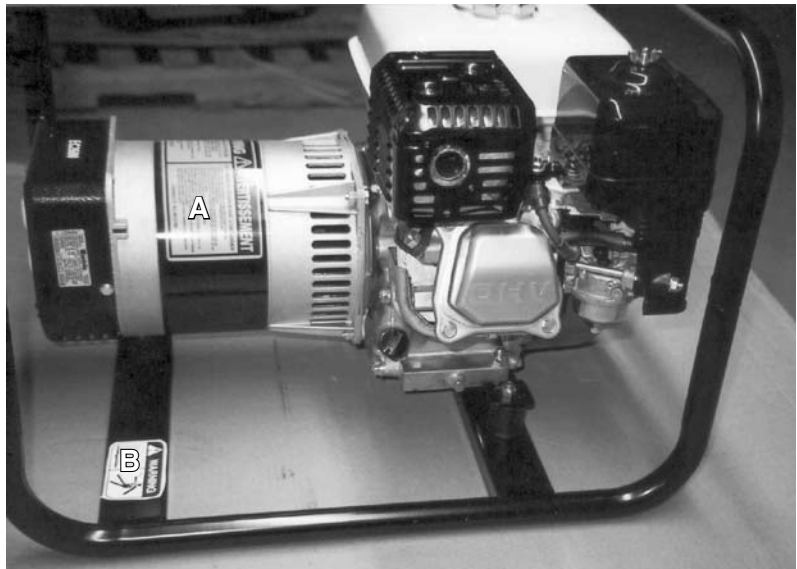

EC2600

REMEMBER - If safety signs have been damaged, removed, become illegible or parts replaced without safety signs, new signs must be applied. New safety signs are available from your authorized dealer.

4 ASSEMBLING

The machine comes from the factory in a shipping carton and configuration. Always use tools equipment and forklifts of appropriate size and capacity for the job. Always use 2 men when lifting, moving and assembling the machine.

When the machine is shipped, follow this procedure when preparing for the customer:

1. Clear the area of bystanders especially small children before starting.
2. Move the machine to the assembly area. Be sure there is sufficient clearance to access the machine from all sides.



Fig. 1 TYPICAL

3. Open the carton.



Open

4. Use a hoist or a crane to lift the unit out of its carton.

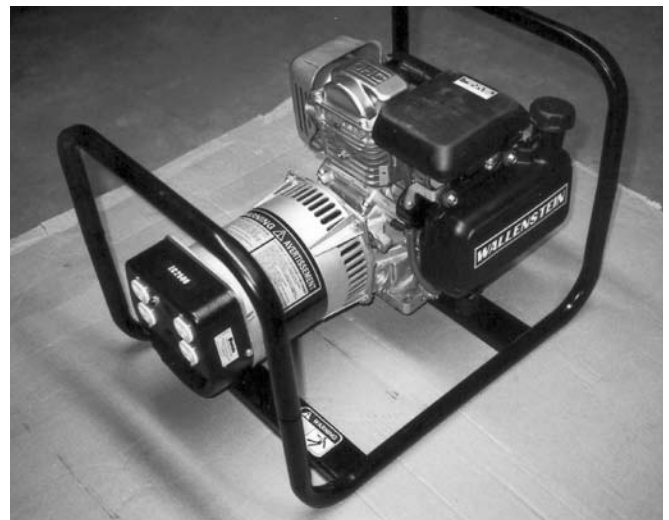

Out

Fig. 2 UNPACKING

5 OPERATION



OPERATING SAFETY

- Read and understand operator's manual before starting. Review safety instructions annually.
- Stop and disable engine, remove ignition key and place in your pocket and wait for all moving parts to stop before servicing, adjusting or repairing.
- To prevent electrical shocks, do not operate this generator in the rain or with wet hands. It should be grounded in damp or highly conductive conditions.
- Close and secure all guards, deflectors and shields before starting and operating.
- Do not connect the generator to a commercial power line.
- Do not operate with damaged or defective extension cords, or power cords. Never operate any electrical equipment with damaged or defective cords.
- Do not operate this generator in areas with poor ventilation. The exhaust fumes contain carbon monoxide, a poisonous, odorless, invisible gas. Prolonged exposure can lead to unconsciousness and death.
- Do not refuel the engine while it is in operation or still hot. Do not refuel the engine near open flames, pilot lights or sparking electrical devices (e.g. power tools, welders or grinders). Do not operate the generator near flammable products.
- The engine should be refuelled in a well-lit area. Avoid fuel spillage.
- Never allow children or unauthorized people to operate or be around this machine.
- Keep the working area clean and free of debris to prevent tripping. Operate only on level ground.
- Do not cover the generator while in operation. Overheating can result in damaged equipment.
- For storage, do not cover the generator until it has cooled down completely.
- The ambient temperature should not exceed 100° F/40° C.

5.1 TO THE NEW OPERATOR OR OWNER

The Wallenstein Portable Generators are designed to provide portable electrical power to equipment that is not connected to the electrical grid system.

It is the responsibility of the owner or operator to read this manual and to train all other operators before they start working with the machine. Follow all safety instructions exactly. Safety is everyone's business. By following recommended procedures, a safe working environment is provided for the operator, bystanders and the area around the work site. Untrained operators are not qualified to use the machine.

Follow all safety instructions exactly. Safety is everyone's business. By following recommended procedures, a safe working environment is provided for the operator, bystanders and the area around the work site. Untrained operators are not qualified to operate the machine.

Many features incorporated into this machine are the result of suggestions made by customers like you. Read this manual carefully to learn how to use the Generator safely and how to set it to provide maximum field efficiency. By following the using instructions in conjunction with a good maintenance program, your Portable Generator will provide many years of trouble-free service.

5.2 MACHINE COMPONENTS

The Wallenstein EC Portable Generator consists of a 5.0, 5.5, 6.5 or 9.0 hp Honda engine driving a 2500, 2600, 3300 or 5000 watt electrical generator. All control and power outlets are mounted on the end of the frame for convenient access and operation.

The unit is designed to provide 120 V 60 Hz power as a back up power supply at a remote location. Each outlet is designed with a circuit breaker to protect against overload. The generator is neutral bonded to the frame. The fuel tank is part of the engine and mounted in the frame.

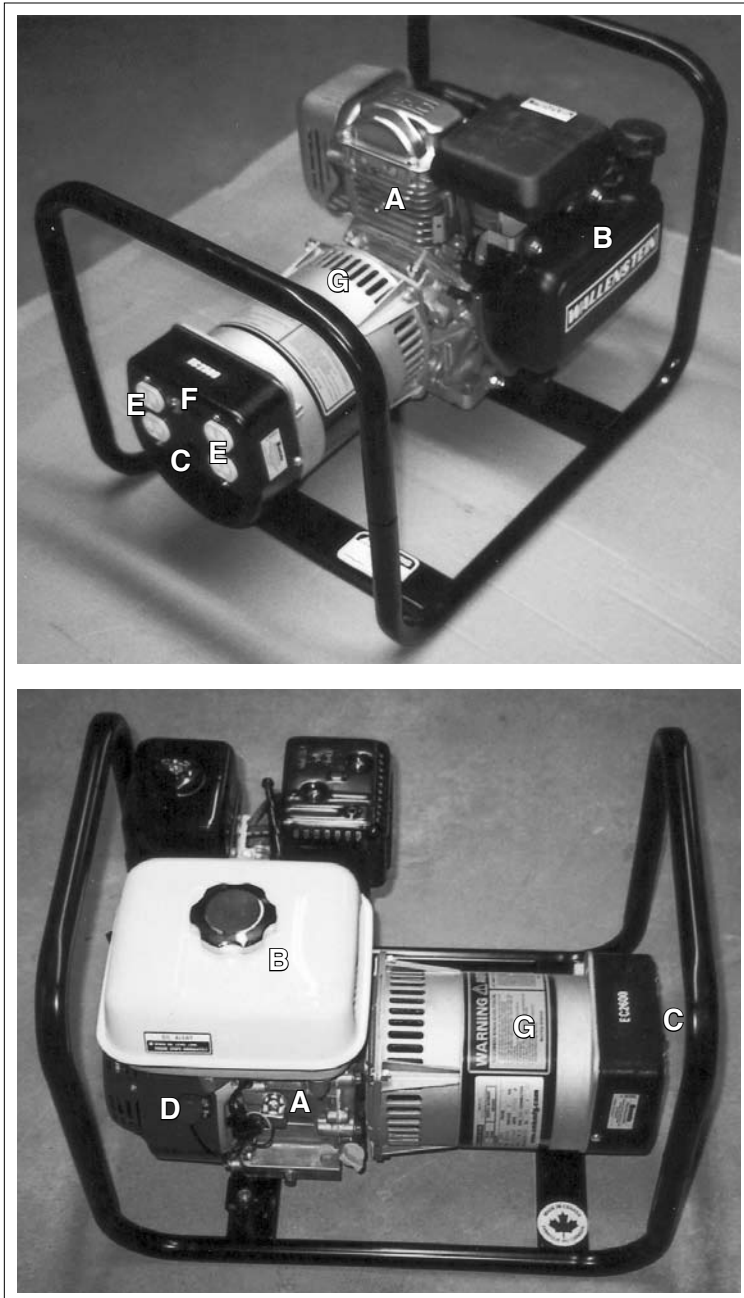

- A Engine
- B Fuel Tank
- C Control Panel
- D Ignition Switch
- E 120 V Outlets
- F Circuit Breaker
- G Generator

Fig. 3 PRINCIPLE COMPONENTS

5.3 MACHINE BREAK-IN

Although there are no operational restrictions on the Portable Generator when used for the first time, it is recommended that the following mechanical items be checked:

A. After operating for 1 hour:

1. Re-torque all fasteners and hardware.
2. Check condition of all electrical connections.
3. Check fluid levels. Top up as required.

B. After operating for 10 hours:

1. Repeat steps 1 through 3 listed above. (Section A)
2. Change engine oil.
3. Go to the normal servicing and maintenance schedule as defined in the Maintenance Section.

5.4 PRE-OPERATION CHECKLIST

Efficient and safe operation of the Wallenstein Portable Generator requires that each operator reads and understands the using procedures and all related safety precautions outlined in this section. A pre-operation checklist is provided for the operator. It is important for both the personal safety and maintaining good mechanical condition that this checklist is followed.

Before operating Portable Generator and each time thereafter, the following areas should be checked off:

1. Check engine fluid levels. Top up as required.
2. Check all electrical connections. Replace, repair or clean as required.
3. Make sure that all guards and shields are in place, secured and functioning as designed.

5.5 CONTROLS

Before starting to work, all operators should familiarize themselves with the location and function of controls.

1. Gas Engine:

Read the engine manufacturers operator's manual before starting for more detailed instructions.

a. Ignition Switch:

This switch controls the electrical power to the engine electrical system. Turn the switch counter-clockwise to turn OFF. Turn clockwise to the first position for ON.

b. Choke:

This lever controls the position of the choke. Slide the lever to the left to close the choke valve for starting when the engine is cold. Slide to the right to open the choke as the engine warms. Always open the choke fully when operating the machine.

c. Throttle:

This lever controls the engine RPM. The engine always runs at maximum RPM when operating.

d. Fuel Shut-Off Valve:

This valve controls the flow of fuel to the engine. Turn the valve at right angles to the fuel line to turn the fuel off and parallel to turn the fuel on.

e. Starting Rope:

This retracting rope and T-bar is used to turn the engine over for starting. Grasp the T-bar firmly and pull the rope sharply to start the engine. Close the choke if the engine is cold.

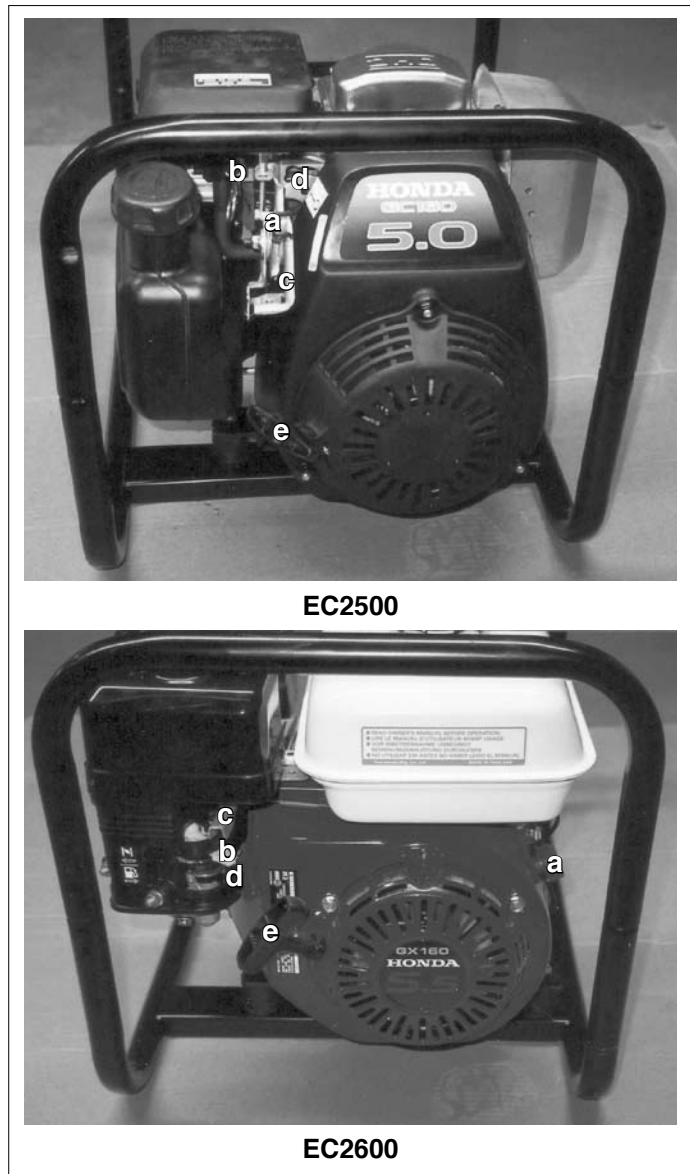

Fig. 4 ENGINE CONTROLS

2. Electrical Controls:

- a. **120 Volt, 15 Amp Outlets:** These outlets are used to provide 120 Volt, 15 Amp power to the customer.
- b. **120 Volt, 20 Amp Outlets:** These outlets are used to provide 120 Volt, 20 Amp power to the customer.
- c. **120 Volt, 30 Amp Outlets:** These outlets are used to provide 120 volt, 30 amp power to the customer.
- d. **240 Volt, 20 Amp Outlets:** These outlets are used to provide 240 volt, 20 amp power to the customer.
- e. **Circuit Breakers:** These push switches are used to reset the circuit breakers to the adjacent outlets. Push the switch to reset the breaker if it is tripped.

IMPORTANT

A circuit breaker that trips repeatedly may indicate a problem.



EC2500

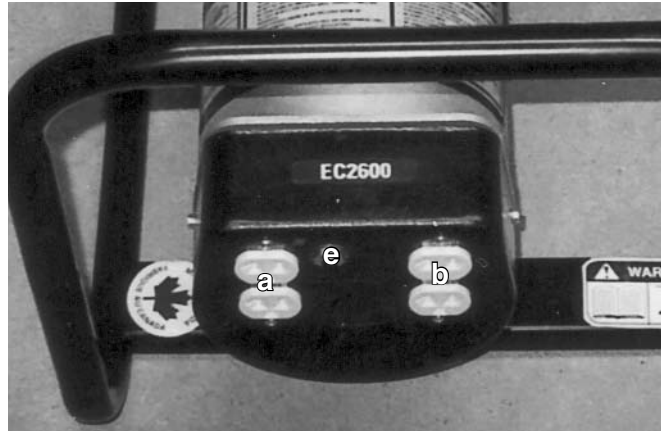

EC2600

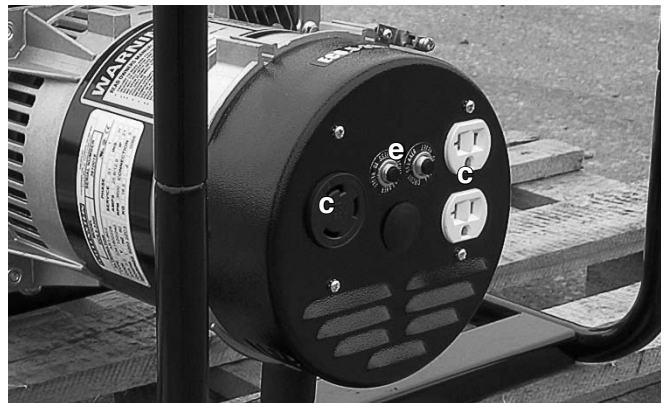

EC3300

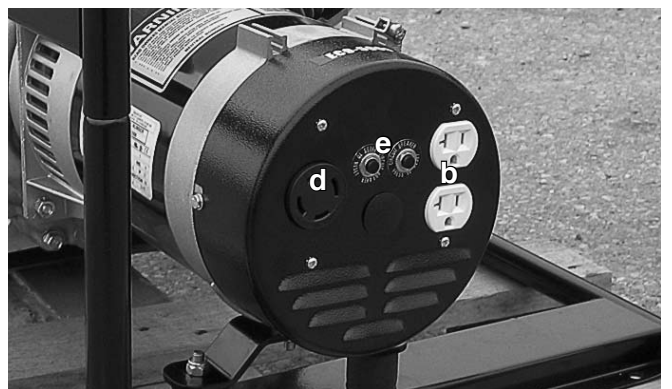

EC5000

Fig. 5 ELECTRICAL CONTROLS

5.6 FIELD OPERATION



OPERATING SAFETY

- Read and understand operator's manual before starting. Review safety instructions annually.
- Stop and disable engine, remove ignition key and place in your pocket and wait for all moving parts to stop before servicing, adjusting or repairing.
- To prevent electrical shocks, do not operate this generator in the rain or with wet hands. It should be grounded in damp or highly conductive conditions.
- Close and secure all guards, deflectors and shields before starting and operating.
- Do not connect the generator to a commercial power line.
- Do not operate with damaged or defective extension cords, or power cords. Never operate any electrical equipment with damaged or defective cords.
- Do not operate this generator in areas with poor ventilation. The exhaust fumes contain carbon monoxide, a poisonous, odorless, invisible gas. Prolonged exposure can lead to unconsciousness and death.
- Do not refuel the engine while it is in operation or still hot. Do not refuel the engine near open flames, pilot lights or sparking electrical devices (e.g. power tools, welders or grinders). Do not operate the generator near flammable products.
- The engine should be refuelled in a well-lit area. Avoid fuel spillage.
- Never allow children or unauthorized people to operate or be around this machine.
- Keep the working area clean and free of debris to prevent tripping. Operate only on level ground.
- Do not cover the generator while in operation. Overheating can result in damaged equipment.
- For storage, do not cover the generator until it has cooled down completely.
- The ambient temperature should not exceed 100° F/40° C.

Although the Portable Generator is easy to use, each operator should review this section to familiarize himself with the detailed safety and operating procedures. When using this machine, follow this procedure:

1. Clear the area of bystanders, especially small children.
2. Review and follow the Pre-Operation Checklist (see Section 5.4).
3. Position the generator in the following manner:
 - a. Level to minimize the chance of spilling fuel.
 - b. In a dry area to prevent shocks and shorts.
 - c. Away from all flammable liquids and fumes.
 - d. With a ground to minimize the chance of shocks and shorts.

4. **Starting the Generator:**

- a. Plug in power cords from appliances or loads.
- b. Turn all the appliances or electrical loads off.
- c. Refer to engine manual for detailed engine starting procedure.
- d. Turn the ignition switch ON.
- e. Pull out the choke if the engine is cold or hasn't been run for awhile.
- f. Pull sharply on the starting T-bar to start the engine.
- g. Run the engine until it warms and the choke is completely closed.
- h. Turn the appliance on or plug in the electrical load.

5. **Stopping:**

- a. Turn the appliance off or unplug the electrical load.
- b. Run the engine for approximately three minutes to allow the engine to cool.
- c. Turn engine off.

6. **Emergency Stopping:**

Turn the engine off if an emergency arises. Correct the condition before resuming work and re-starting the engine.

7. **Terrain:**

The generator works well in a wide variety of operating conditions but it should always be positioned on the level. When the frame is level, fuel spillage is minimized and the gas tank capacity is maximized. Do not operate unless the frame is level.



EC2500

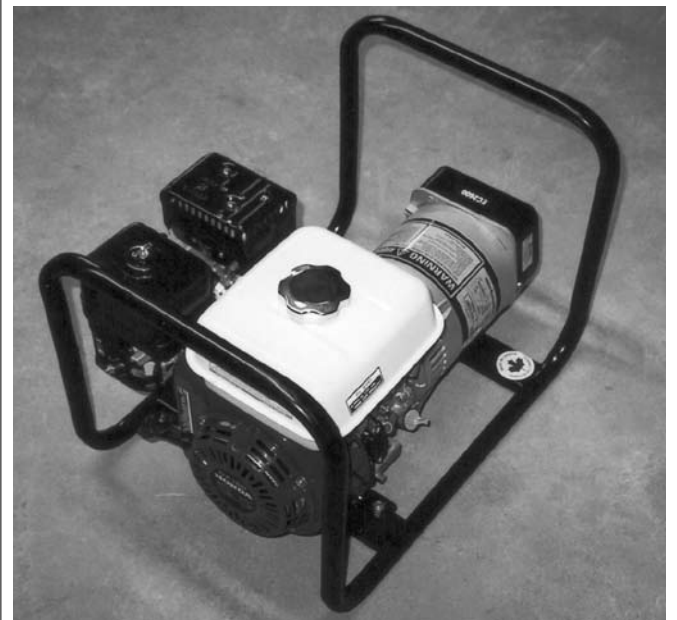

EC2600

Fig. 6 STARTING/STOPPING

8. Weather:

- a. Do not operate in the rain or with wet hands. Keep the generator and work area dry to prevent shocks and shorts. Always ground the frame when operating in damp or wet conditions.
- b. Do not operate at temperatures above 100° F (40° C) to prevent overheating of the engine or generator. Always run for approximately three minutes without an electrical load to cool the components before shutdown.

9. Electrical Loads:

The generator is ideally suited to camping, boating, farm, household, workshop, construction site or anywhere that back-up power is required. In order to determine the power requirements of your appliance, refer to Table 1. There are approximations only. If the power draw for the appliance exceeds the outlet capacity, the circuit breaker will be tripped. Reduce the current draw and reset the breaker before resuming operation.

Generator Usage	Start Watts	Running Watts	EC2500, EC2600, EC3300 & EC5000
Refrigerator, Freezer	2500	700	Y
Toaster		1050	Y
Microwave		950	Y
Coffee Maker	1500	850	Y
Washing Machine	2000	750	Y
Furnace Fan	1400	700	Y
Sump Pump	2500	600	Y
TV		350	Y
Circular Saw	1500	750	Y
Drill	1000	250	Y
Sander	1000	375	Y
Y=WILL OPERATE			
PLEASE NOTE THAT THIS TABLE REPRESENTS A SAMPLE OF APPLICATIONS ONLY			

Fig. 7 TABLE 1

10. Electrical Component Condition:

Always use electrical components that are in good condition. Do not use electrical cords, plugs and connectors that are frayed, damaged, cracked or not in good condition. Electrical components that are not in good condition can lead to shocks, shorts or sparking. Any of these conditions can create and lead to an undesirable or unsafe situation.

11. Electrical Hazards:

The generator is designed to generate an electrical current at a high enough power level to get meaningful work done. However, power at these levels also includes the possibility of electrical hazards. Some things to remember about electrical hazards include but are not limited to:

- a. Keep all electrical components in good condition.
- b. Do not operate with frayed, cracked or damaged parts.
- c. Ground the frame if operating in damp or wet conditions.
- d. Do not operate with wet hands.

12. Circuit Breakers:

Each set of outlets on the electrical panel is designed with a circuit breaker to prevent overloading the circuit. If a breaker trips, reduce the load before re-setting the breaker.

IMPORTANT

A circuit breaker that trips repeatedly may indicate a problem.

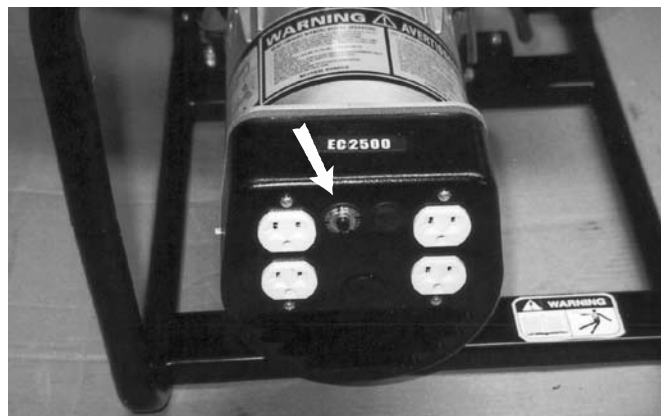

EC2500

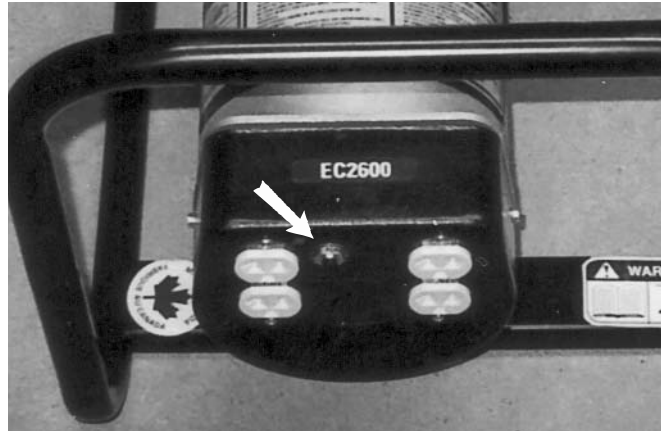

EC2600

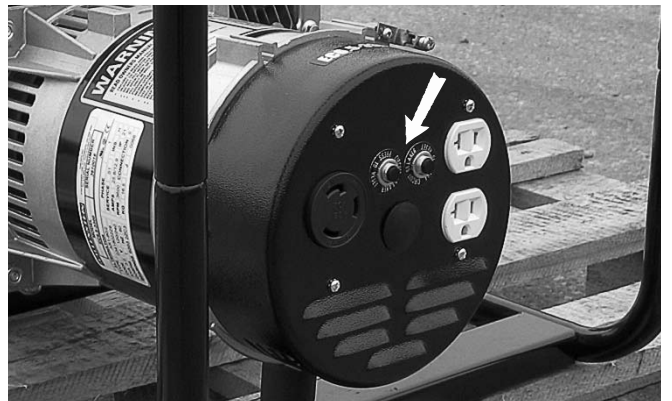

EC3300

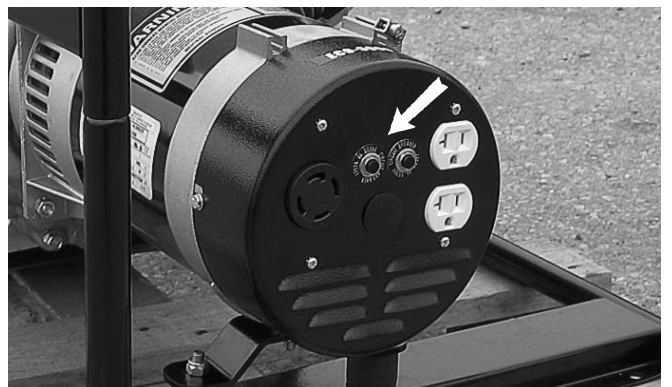

EC5000

Fig. 8 CONTROL PANEL

13. Operating Hints:

- a. Position frame on a level area to minimize the chance of spilling fuel and maximize the fuel capacity of the tank. Spilled fuel can be ignited by a spark from the electrical power system.
- b. Do not refuel while the engine is running. Wait until the unit has cooled before refuelling.
- c. Keep the working area neat and clean to prevent slipping and tripping. Prevent accidents at the work site.
- d. Always ground the frame to minimize the chance of sparks, shocks or shorts. This is very important in damp, wet or rainy conditions.
- e. Position the generator under cover to protect it from rain or bad weather.
- f. Do not operate when the ambient temperature exceeds 100° F (39° C) to prevent overheating.
- g. Do not cover the unit during operation to prevent overheating.

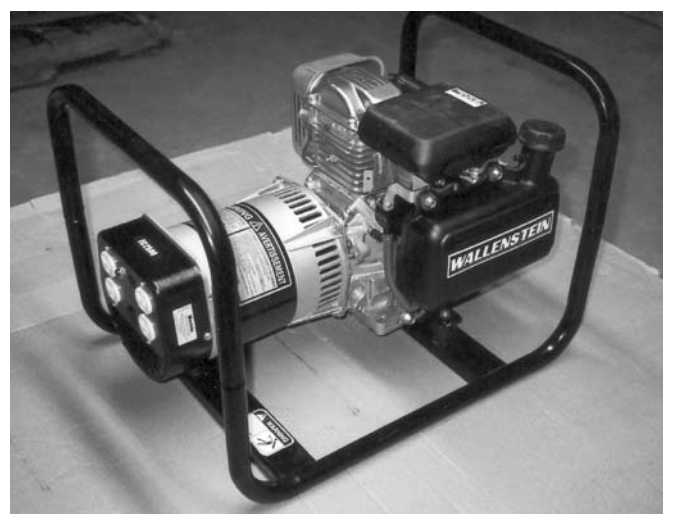

EC2500

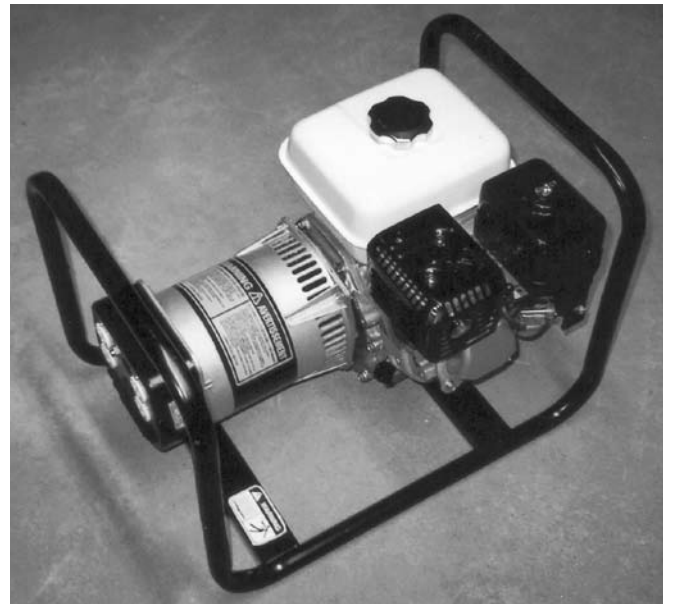

EC2600

Fig. 9 GENERATORS (Typical)

5.7 MOVING

The generator is designed to be easily moved from one location to another. Review the following details on how the unit can be moved:

1. Lift Frame:

The machine is designed with a frame that provides 2 locations for moving with an A frame, forklift, crane or by hand.



Fig. 10 LIFT FRAME (Typical)

2. Wheel Kit:

A wheel kit is available to move the generator. Place the frame into the wheel kit and move to the new location.



Fig. 11 WHEEL UNIT

3. Transporting:

When transporting from location to location, follow this procedure:

- a. Run the engine (use the generator) until the fuel tank is empty or nearly empty.
- b. Turn the fuel valve off.



Fig. 12 FUEL VALVE (Typical)

5.8 STORAGE



OPERATING SAFETY

- Store the unit in an area away from human activity.
- Do not permit children to play on or around the stored machine.
- Store the unit in a dry, level area. Support the frame with planks if required.

5.8.1 PLACING IN STORAGE

After the season's use or when the machine will not be used for a period of time, completely inspect all major systems of the Portable Generator. Replace or repair any worn or damaged components to prevent any unnecessary down time at the beginning of the next season.

Follow this procedure before storing:

1. Remove all plugs or electrical loads from the electrical panel.
2. Thoroughly clean the machine with a damp cloth to remove all dirt, mud or debris.
3. Inspect all rotating parts for entangled material. Remove all entangled material.
4. Turn fuel valve off.
5. Touch up all paint nicks and scratches to prevent rusting.
6. It is best to store the machine inside. If that is not possible, cover with a waterproof tarpaulin and tie down securely.
7. Store in an area away from human activity.
8. Do not allow children to play around the stored unit.

5.8.2 REMOVING FROM STORAGE

When removing this machine from storage, follow this procedure:

1. Remove the tarpaulin if covered.
2. Review and follow the pre-operation checklist.

IMPORTANT

If the machine has been stored for more than 6 months, warm the engine by running it for 2-3 minutes and drain the oil. Change the oil while the oil is warm to remove any condensation. Refer to Maintenance section.



Fig. 13 STORED (Typical)

6 SERVICE AND MAINTENANCE



MAINTENANCE SAFETY

- Good maintenance is your responsibility. Poor maintenance is an invitation to trouble.
- Follow good shop practices.
 - Keep service area clean and dry.
 - Be sure electrical outlets and tools are properly grounded.
 - Use adequate light for the job at hand.
- Make sure there is plenty of ventilation. Never operate the engine of the towing vehicle in a closed building. The exhaust fumes may cause asphyxiation.
- Before working on this machine, shut off the engine, set the brake, and turn fuel valve off.
- Never work under equipment unless it is blocked securely.
- Always use personal protection devices such as eye, hand and hearing protectors, when performing any service or maintenance work. Use heavy gloves when handling sharp components.
- Where replacement parts are necessary for periodic maintenance and servicing, genuine factory replacement parts must be used to restore your equipment to original specifications. The manufacturer will not be responsible for injuries or damages caused by use of unapproved parts and/or accessories.
- A fire extinguisher and first aid kit should be kept readily accessible while performing maintenance on this equipment.
- Periodically tighten all bolts, nuts and screws and check that all electrical and fuel connections are properly secured to ensure unit is in a safe condition.
- When completing a maintenance or service function, make sure all safety shields and devices are installed before placing unit in service.

6.1 SERVICE

6.1.1 FLUIDS AND LUBRICANTS

1. **Grease:**
Use an SAE multipurpose high temperature grease with extreme pressure (EP) performance. Also acceptable is an SAE multipurpose lithium base grease.
2. **Engine Oil:**
Use an SAE 10W30 or 10W40 multi-viscosity oil meeting the American Petroleum Institute (API) classification of SF, SG, SH or SJ for normal operating temperatures. Consult the engine manual for unusual operating conditions. Do not mix oil types or viscosities.

Crankcase Capacity:

5.0 hp	0.6 L (0.65 US qt)
5.5 hp	0.75 L (0.75 US qt)
6.5 hp	0.92 L (1.0 US qt)
9.0 hp	1.1 L (1.2 US qt)

3. **Engine Gasoline:**
Use a standard automotive unleaded gasoline for all operating conditions.

Fuel Tank Capacity:

5.0 hp	2.0 L (2.1 US qt)
5.5 hp	3.7 L (1.0 US gal)
6.5 hp	3.7 L (1.0 US gal)
9.0 hp	6.0 L (1.6 US gal)

4. **Storing Lubricants:**
Your machine can operate at top efficiency only if clean lubricants are used. Use clean containers to handle all lubricants. Store them in an area protected from dust, moisture and other contaminants.

6.1.1 FLUIDS AND LUBRICANTS

Use the Maintenance Checklist provided to keep a record of all scheduled maintenance.

1. Use a hand-held grease gun for all greasing.
2. Wipe grease fitting with a clean cloth before greasing, to avoid injecting dirt and grit.
3. Replace and repair broken fittings immediately.
4. If fittings will not take grease, remove and clean thoroughly. Also clean lubricant passageway. Replace fittings if necessary.

6.1.2 SERVICING INTERVALS

The period recommended is based on normal operating conditions. Severe or unusual conditions may require more frequent lubrication or oil changes.

8 Hours or Daily

1. Check engine oil level.
2. Check fuel level.

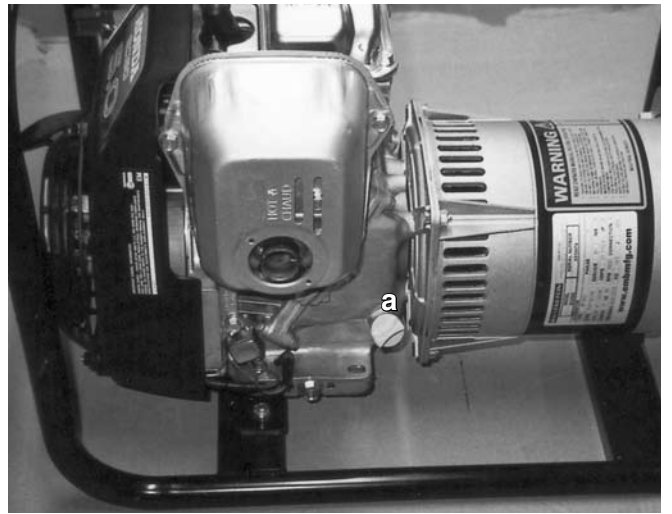

EC2500 a. Oil Level



EC2500 b. Fuel Level



EC2600
a. Oil Level b. Fuel Level

Fig. 14 ENGINE (Typical)

40 Hours or Weekly

1. Clean engine air cleaner.

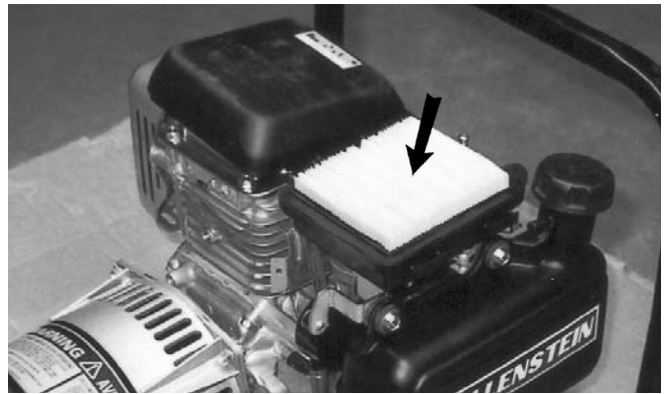

EC2500



EC2600

Fig. 15 AIR CLEANER (Typical)

100 Hours or Monthly

1. Change engine oil.

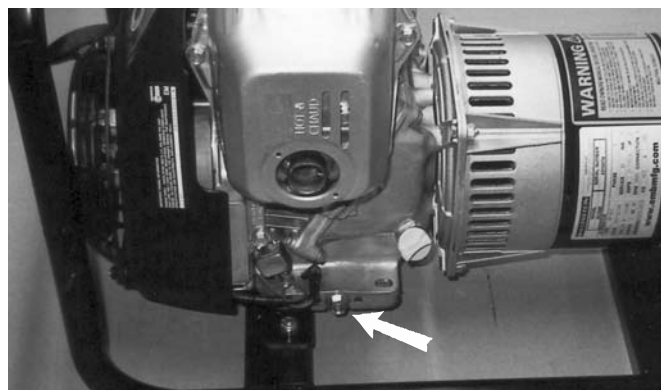

EC2500

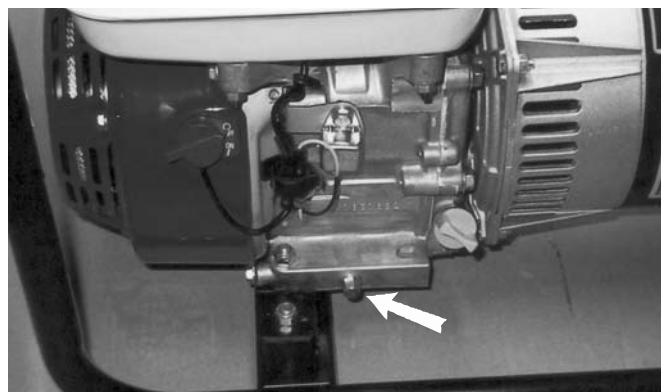

EC2600

Fig. 16 DRAIN PLUG (Typical)

100 Hours or Monthly

2. Replace engine air cleaner.

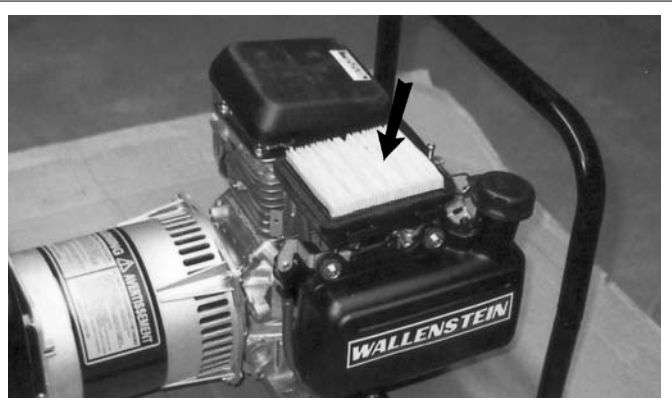

EC2500

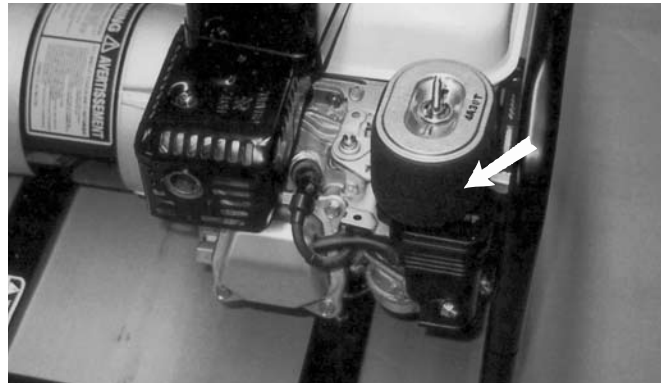

EC2600

Fig. 17 AIR CLEANER (Typical)

Annually

1. Clean machine.



EC2500

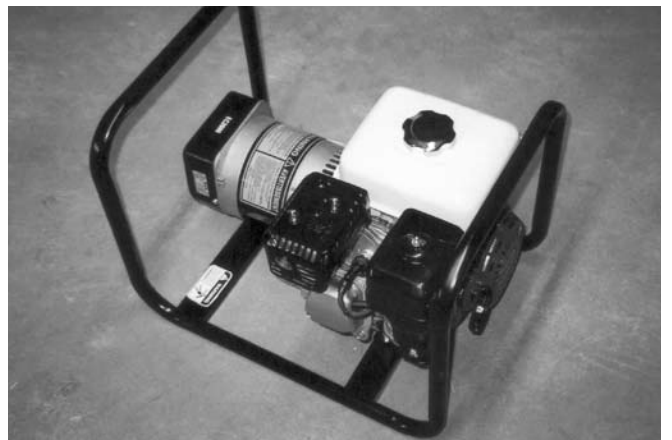

EC2600

Fig. 18 MACHINE

6.1.3 SERVICE RECORD

See Lubrication and Maintenance sections for details of service. Copy this page to continue record.

ACTION CODE CK CHECK CL CLEAN R REPLACE
 CH CHANGE

MAINTENANCE	HOURS																		
	SERVICED BY																		
8 Hours or Daily																			
CK	Engine Oil Level																		
CK	Fuel Level																		
40 Hours or Weekly																			
CL	Air Cleaner																		
100 Hours or Monthly																			
CH	Engine Oil																		
R	Air Cleaner																		
Annually																			
CL	Machine																		

6.2 MAINTENANCE

By following a careful service and maintenance program for your machine, you will enjoy many years or trouble-free operation.

6.2.1 CLEANING AIR CLEANER

1. Review the Operator's Manual for the engine.
2. Place all controls in neutral, stop engine and remove ignition key and place in pocket before maintaining.
3. Remove the cover over the air cleaner.
4. Remove the filter from the engine.
5. Use an air house to blow the dust and debris out of the filter.
6. Install filter.
7. Install and secure the cover.

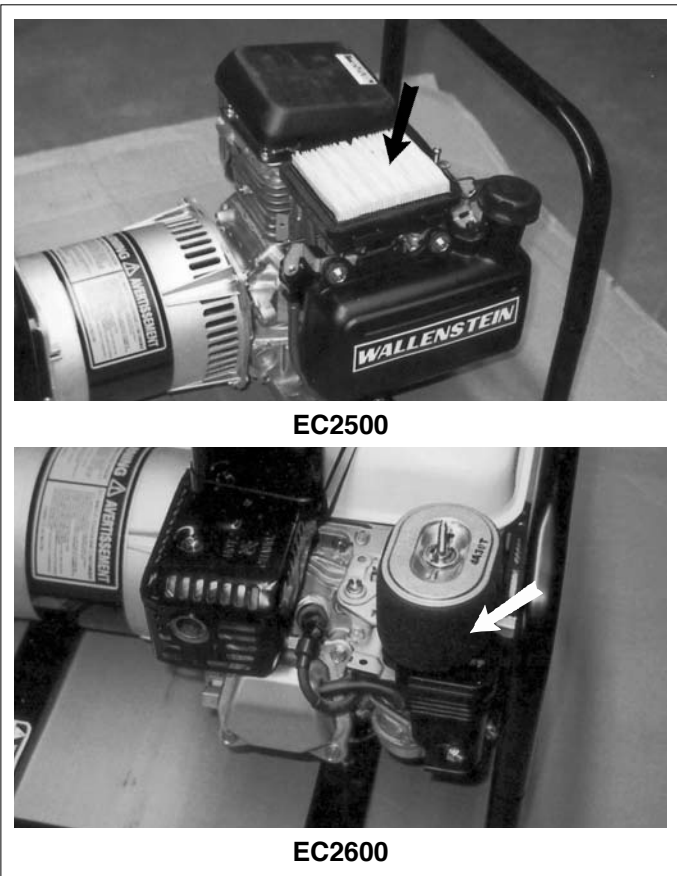

Fig. 19 AIR CLEANER (Typical)

6.2.2 CHANGING ENGINE OIL

1. Review the Operator's Manual for the engine.
2. Place all controls in neutral, stop engine and remove ignition key and place in pocket before maintaining.
3. Allow the engine to cool before changing the oil. Hot oil can cause burns if it contacts exposed skin. It is best to change oil while the engine is warm to keep the contaminants in suspension.
4. Place a pan under the drain plug.
 - a. Drain plug.
 - b. Fill plug.
5. Remove the drain plug and allow the oil to drain for 10 minutes.
6. Install and tighten the drain plug.
7. Dispose of the used oil in an approved container.
8. Run the engine for 1-2 minutes and check for oil leaks.
9. If leaks are found around the drain plug, tighten slightly. Repeat step 8.
10. Check engine oil level. Top up as required.

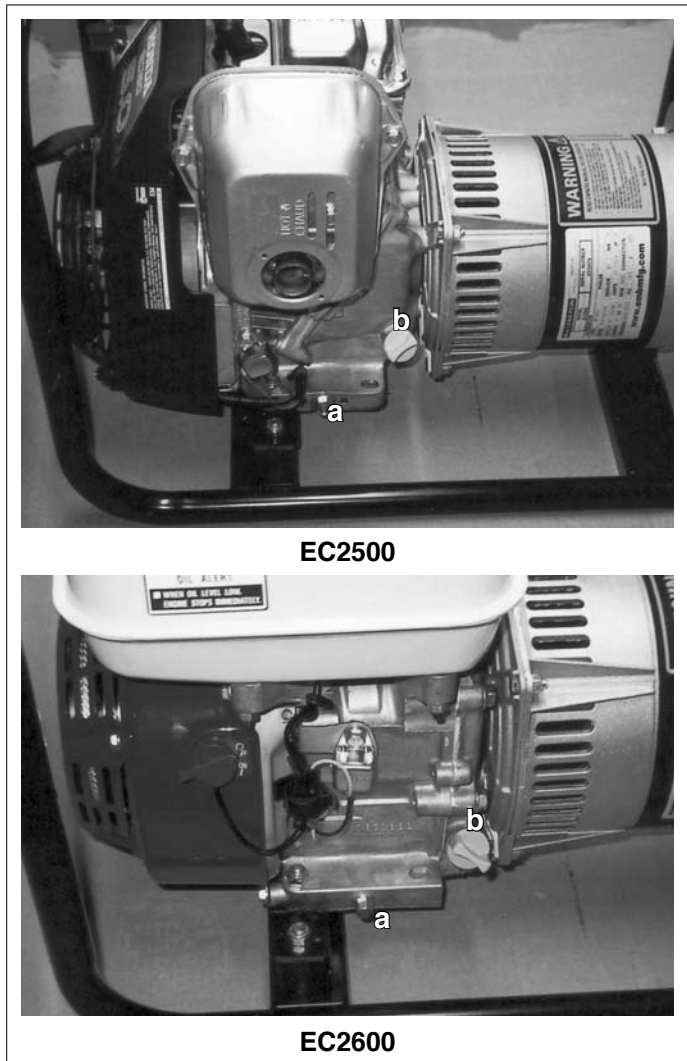

Fig. 20 ENGINE (Typical)

7 TROUBLE SHOOTING

The Wallenstein Portable Generator is designed to generate up to 10,000 continuous watts of power at any type of remote location. It is a simple and reliable system that requires minimal maintenance.

In the following section, we have listed many of the problems, causes and solutions to the problems that you may encounter.

If you encounter a problem that is difficult to solve, even after having read through this trouble shooting section, please call your local distributor or dealer. Before you call, please have this Operator's Manual from your unit and serial number ready.

PROBLEM	CAUSE	SOLUTION
Engine doesn't start.	No fuel.	Fill fuel tank.
	Fuel filter plugged.	Replace fuel filter.
	Weak battery.	Recharge or replace battery.
	Loaded electrically.	Remove electric load.
<hr/>		
Breakers tripping.	Electrical load too high.	Reduce electrical load.

8 SPECIFICATIONS

8.1 MECHANICAL

	EC2500	EC2600	EC3300	EC5000
Max / continuous watts	2500 / 2100	2600 / 2300	3300 / 3000	5000 / 4500
Max / continuous amps (120-V)	20.8 / 17.5	21.6 / 19	27.5 / 25	41.6 / 37.5
Volts / Frequency	120-V / 60 Hz	120-V / 60 Hz	120-V / 60 Hz	120 V / 60 Hz
Full tank capacity	2 litres	3.7 litres	3.7 litres	6.0 litres
Run time (hours) Half / full load	3 / 2.5	4 / 3	4 / 3	4 / 3
Weight (lbs)	68	74	85	122
Dimensions (in) L / W / H	22 / 16 / 16	22 / 16 / 16	22 / 16 / 16	25.5 / 20 / 21

SPECIFICATIONS SUBJECT TO CHANGE WITHOUT NOTICE

8.2 BOLT TORQUE

CHECKING BOLT TORQUE

The tables shown below give correct torque values for various bolts and capscrews. Tighten all bolts to the torques specified in chart unless otherwise noted. Check tightness of bolts periodically, using bolt torque chart as a guide. Replace hardware with the same strength bolt.

ENGLISH TORQUE SPECIFICATIONS

Bolt Diameter "A"	Bolt Torque*					
	SAE 2 (N.m) (lb-ft)		SAE 5 (N.m) (lb-ft)		SAE 8 (N.m) (lb-ft)	
1/4"	8	6	12	9	17	12
5/16"	13	10	25	19	36	27
3/8"	27	20	45	33	63	45
7/16"	41	30	72	53	100	75
1/2"	61	45	110	80	155	115
9/16"	95	60	155	115	220	165
5/8"	128	95	215	160	305	220
3/4"	225	165	390	290	540	400
7/8"	230	170	570	420	880	650
1"	345	225	850	630	1320	970

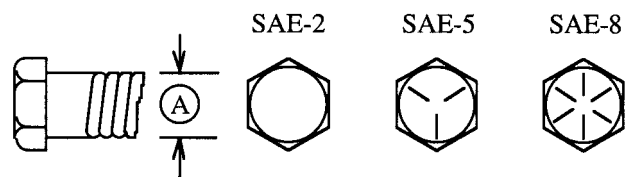

METRIC TORQUE SPECIFICATIONS

Bolt Diameter "A"	Bolt Torque*			
	8.8 (N.m) (lb-ft)		10.9 (N.m) (lb-ft)	
M3	.5	.4	1.8	1.3
M4	3	2.2	4.5	3.3
M5	6	4	9	7
M6	10	7	15	11
M8	25	18	35	26
M10	50	37	70	52
M12	90	66	125	92
M14	140	103	200	148
M16	225	166	310	229
M20	435	321	610	450
M24	750	553	1050	774
M30	1495	1103	2100	1550
M36	2600	1917	3675	2710

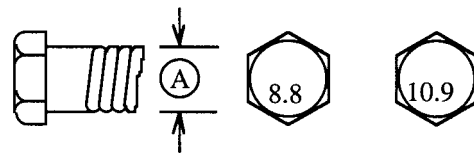

Torque figures indicated above are valid for non-greased or non-oiled threads and heads unless otherwise specified. Therefore, do not grease or oil bolts or capscrews unless otherwise specified in this manual. When using locking elements, increase torque values by 5%.

* Torque value for bolts and capscrews are identified by their head markings.

9 INDEX

A	PAGE
Assembly	12
I	
Index	35
Introduction	1
O	
Operation	13
Controls	16
Field Operation	18
Machine Break-In	15
Machine Components	14
Pre-Operation Checklist	15
Moving	23
Storage	24
To the New Operator or Owner	14

S	PAGE
Safety	2
Equipment Safety Guidelines	4
Gas Motor Safety	8
General Safety	3
Maintenance Safety	6
Operating Safety	7
Preparation	6
Refuelling Safety	7
Safety Signs	5
Safety Training	5
Sign-Off Form	9
Storage Safety	7
Safety Sign Locations	10
Service and Maintenance	25
Maintenance	30
Service	25
Specifications	33
Bolt Torque	33
Mechanical	33
T	
Trouble Shooting	34

WALLENSTEIN

**4144 BOOMER LINE
ST. CLEMENTS, ON
N0B 2M0 CANADA
PH: (519) 699-9283
FAX: (519) 699-4146**